

af **aluminios franco, s.a.**

**Catálogo:
CONSTRUCCIÓN DE
CARROCERÍAS**



FrancoTrans 

**SISTEMAS
CONTINENTAL** 

Pag.	Perfiles
1	Volquete de Obra. 62.140 - 62.032
2	Volquete de Obra. 48.049 - 48.051 - 48.050
3	Volquete de Obra. 06.040
4	Traviesas. 16.011 - 56.192
5	Traviesas. 54.913 - 03.661
6	Traviesas. 69.868 - 56.006
7	Perfiles Comunes. 47.713 - 47.712 - 49.736 - 49.737
8	Volquete Cerealero V30. 55.946
9	Volquete Cerealero V30. 10.619
10	Volquete Cerealero V30. 55.947 - 04.983
11	Paneles V30. 03.934 - 34.492 - 53.837
12	Paneles V30. 34.491 - 04.152
13	Volquete Cerealero V30. 67.133 - 55.961 - 55.960
14	Ganaderos. 54.476 - 54.471 - 54.472
15	Ganaderos. 54.475 - 54.477 - 16.017 - 88.302
16	Ganaderos. 02.585 - 02.588
17	Ganaderos. 62.619 - 88.700 - 88.703 - 88.702 - 88.704
18	Ganaderos. 04.542
19	Plataforma. 56.866
20	Plataforma. 56.005 - 10.987 - 88.801
21	Plataforma. 57.951 - 57.952
22	Plataforma. 75.049
23	Plataforma. 04.020
24	Plataforma. 56.220
25	Plataforma. 03.797
26	Varios. 41.034 - 41.459 - 88.710 - 88.104 - 88.102
27	Varios. 50.232 - 88.404 - 88.502
28	Varios. 51.537 - 51.890
29	Varios. 75.043
30	Varios. 88.304 - 40.539 - 88.303
31	Varios. 58.598 - 76.267
32	Varios. 88.910 - 88.813
33	Varios. 03.649 - 75.036

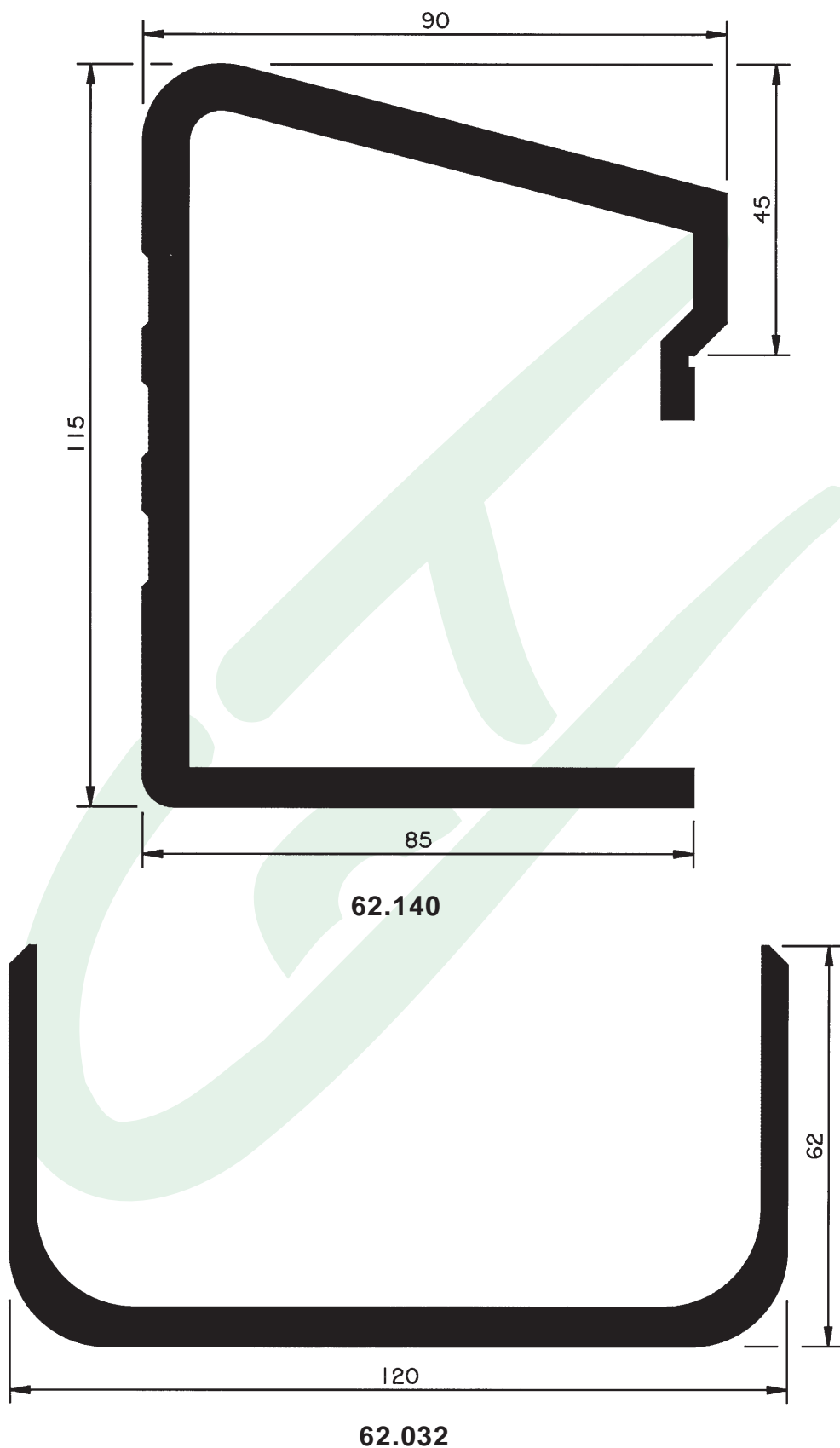

REF. ^a	DENOMINACIÓN	KGR./MT.	LONG. STOCK
62.140	Cerco Volquete Inclinado	5,287	12.500
62.032	Costilla Lateral 120 x 62	3,128	6.300

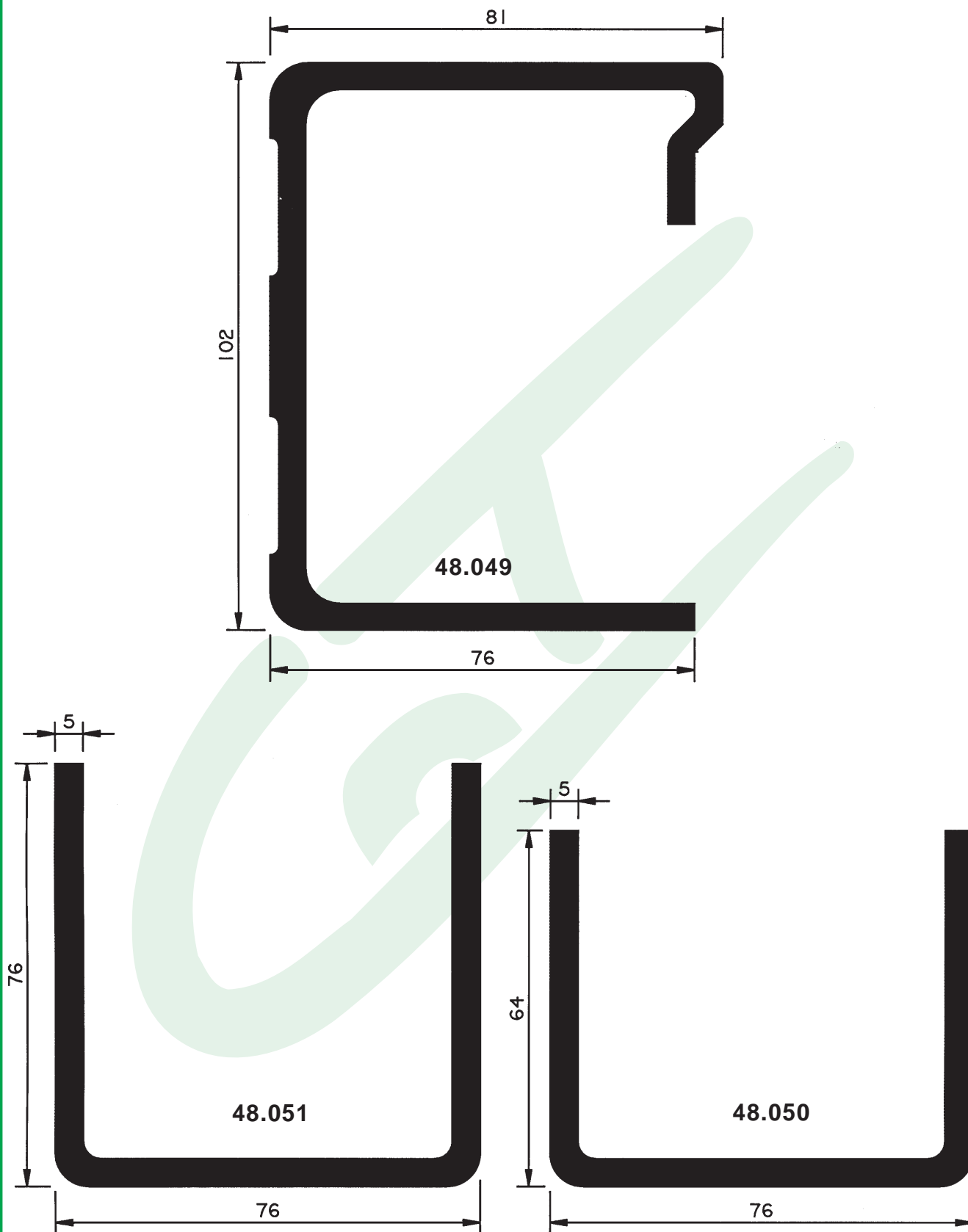

REF. ^a	DENOMINACIÓN	KGR./MT.	LONG. STOCK
48.049	Cerco superior	3,752	7.000
48.051	Costilla Lateral 76 x 76	2,777	7.000
48.050	Costilla Lateral 76 x 64	2,465	7.000

Escala 0.8

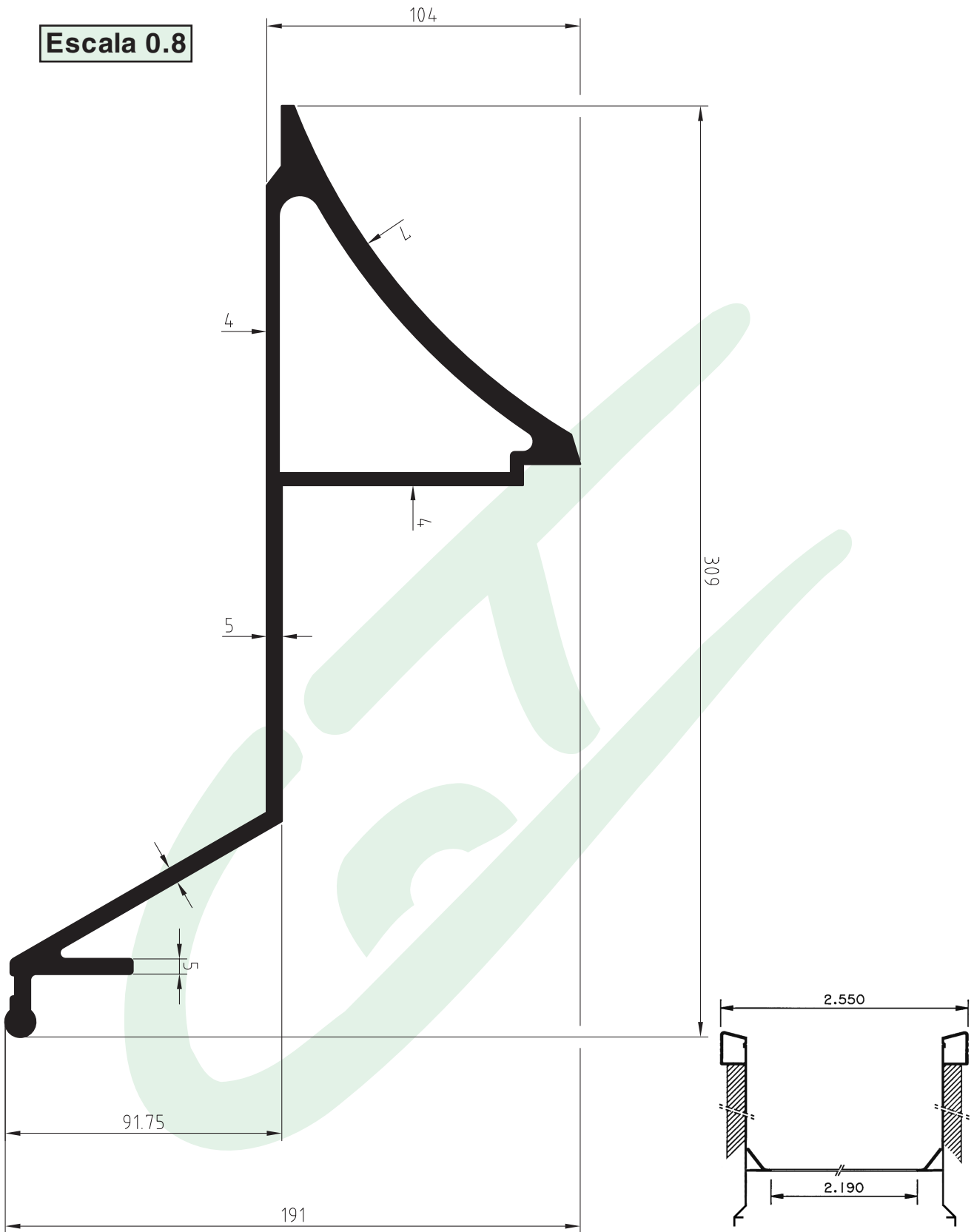

06.040

Detalle de Montaje

REF. ^a	DENOMINACIÓN	KGR./MT.	LONG. STOCK
06.040	Cerco Inferior Volquete Obra 309 mm	9,177	12.500 - 9.000

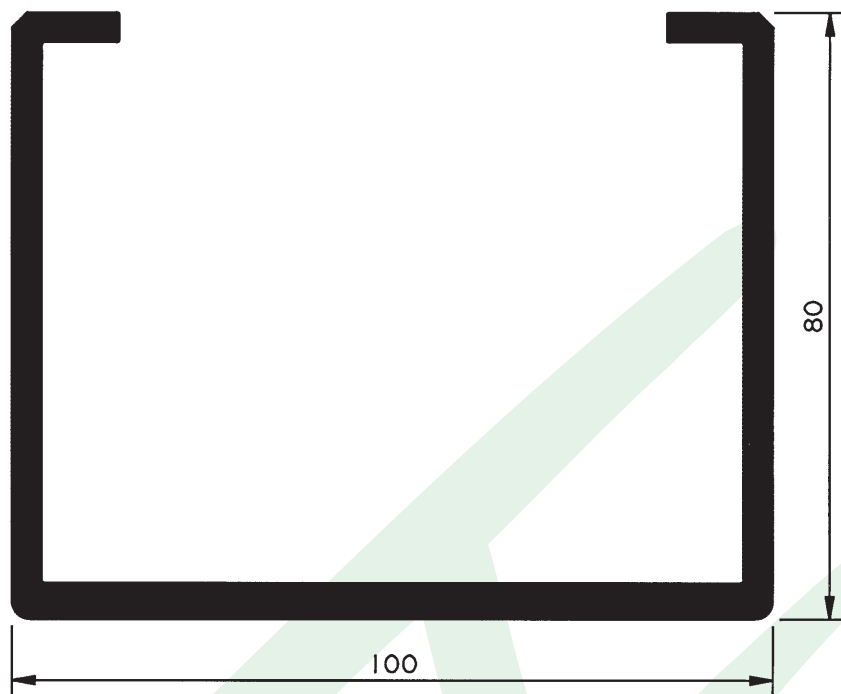

16.011

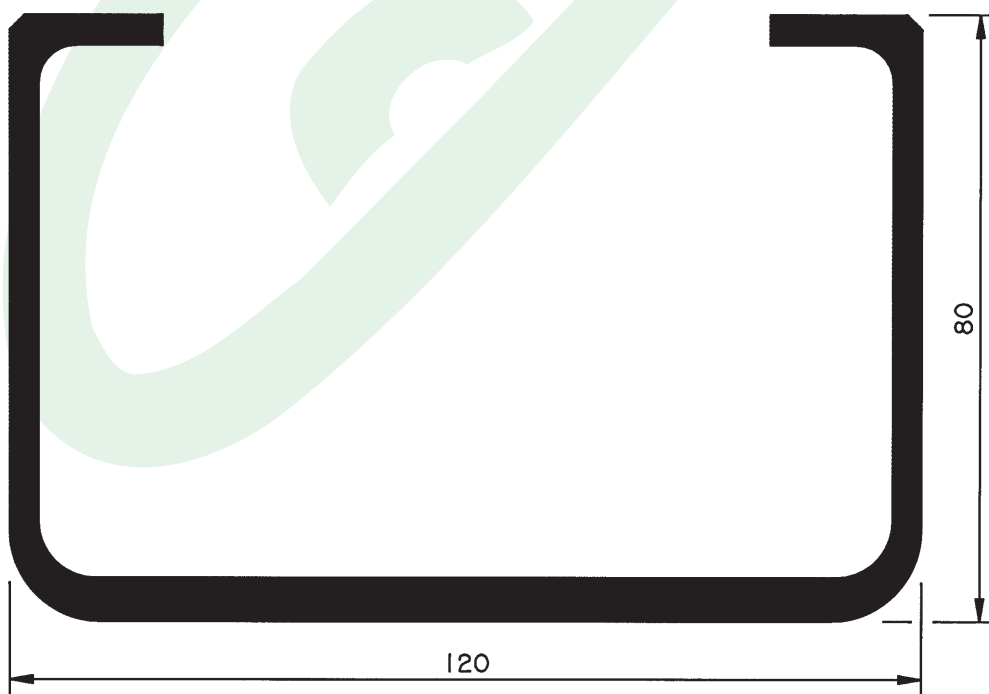

56.192

REF. ^a	DENOMINACIÓN	KGR./MT.	LONG. STOCK
16.011	Traviesas 100	3,197	5.100
56.192	Traviesas 120	3,837	5.100

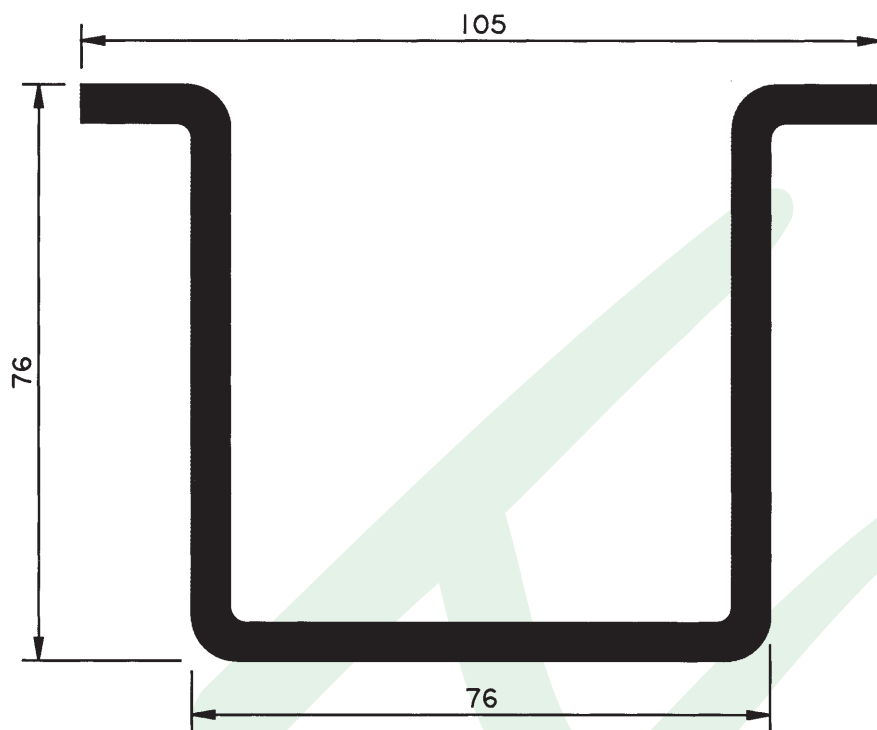

54.913

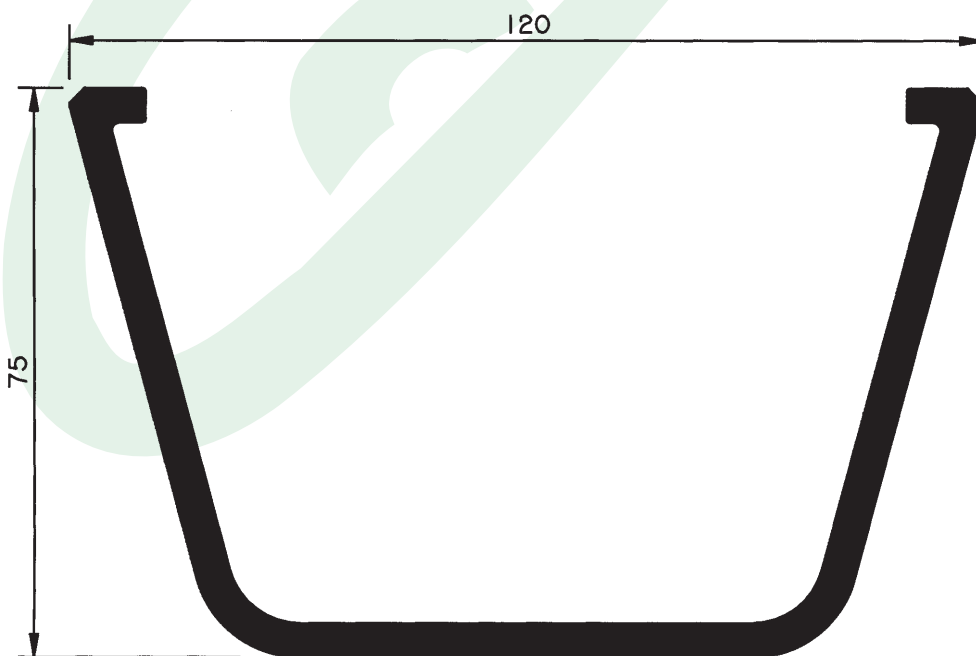

3.661

REF. ^a	DENOMINACIÓN	KGR./MT.	LONG. STOCK
54.913	Traviesas Omega 76 x 76	2,950	5.100
03.661	Traviesas Oblícuca 120	2,836	5.100

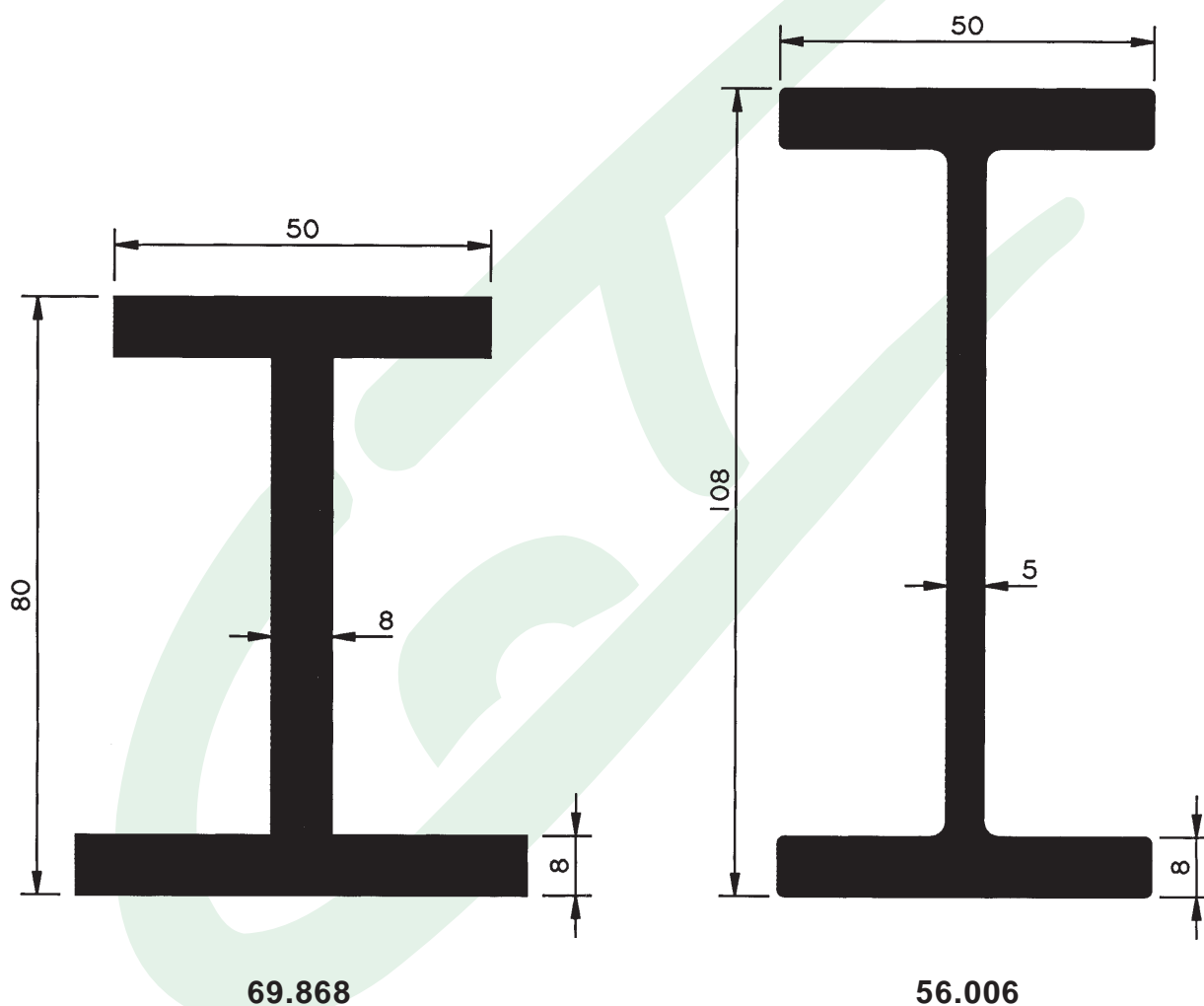

REF. ^a	DENOMINACIÓN	KGR./MT.	LONG. STOCK
69.868	Doble "T" Desigual de 80	3,830	5.100
56.006	Doble "T" de 108	3,499	5.100

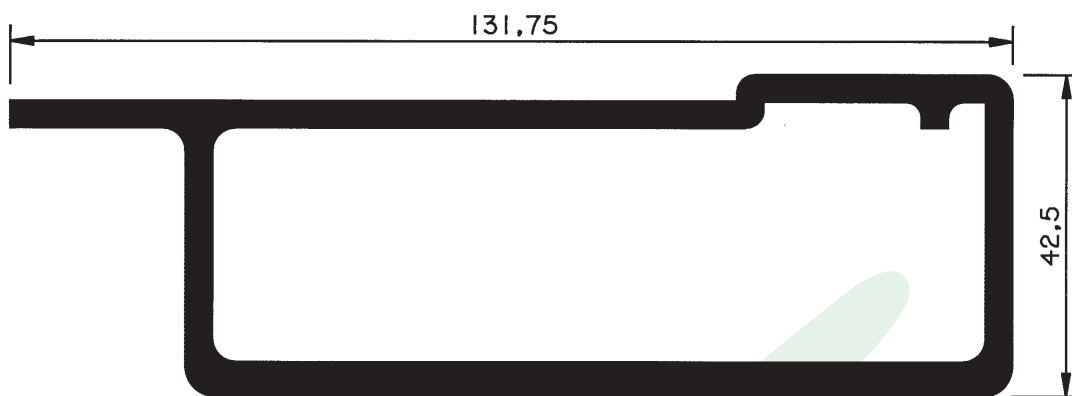

47.713



47.712

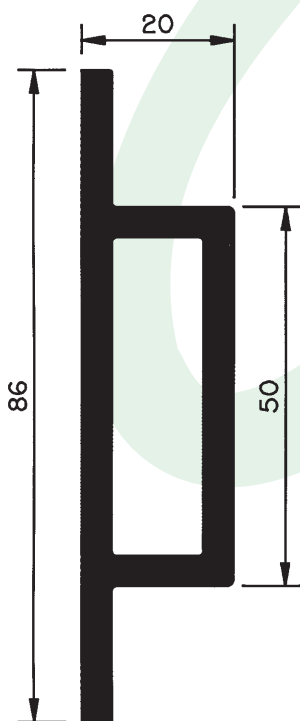

49.736

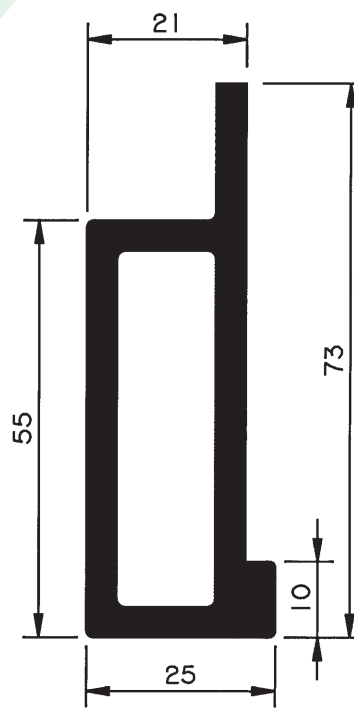

49.737

REF. ^a	DENOMINACIÓN	KGR./MT.	LONG. STOCK
47.713	Pilar Final	3,299	7.000
47.712	Pilar Central	3,379	6.000
49.736	Sombrerillo	1,734	6.000
49.737	Remate Sombrerillo	1,778	6.000

Escala 0.8

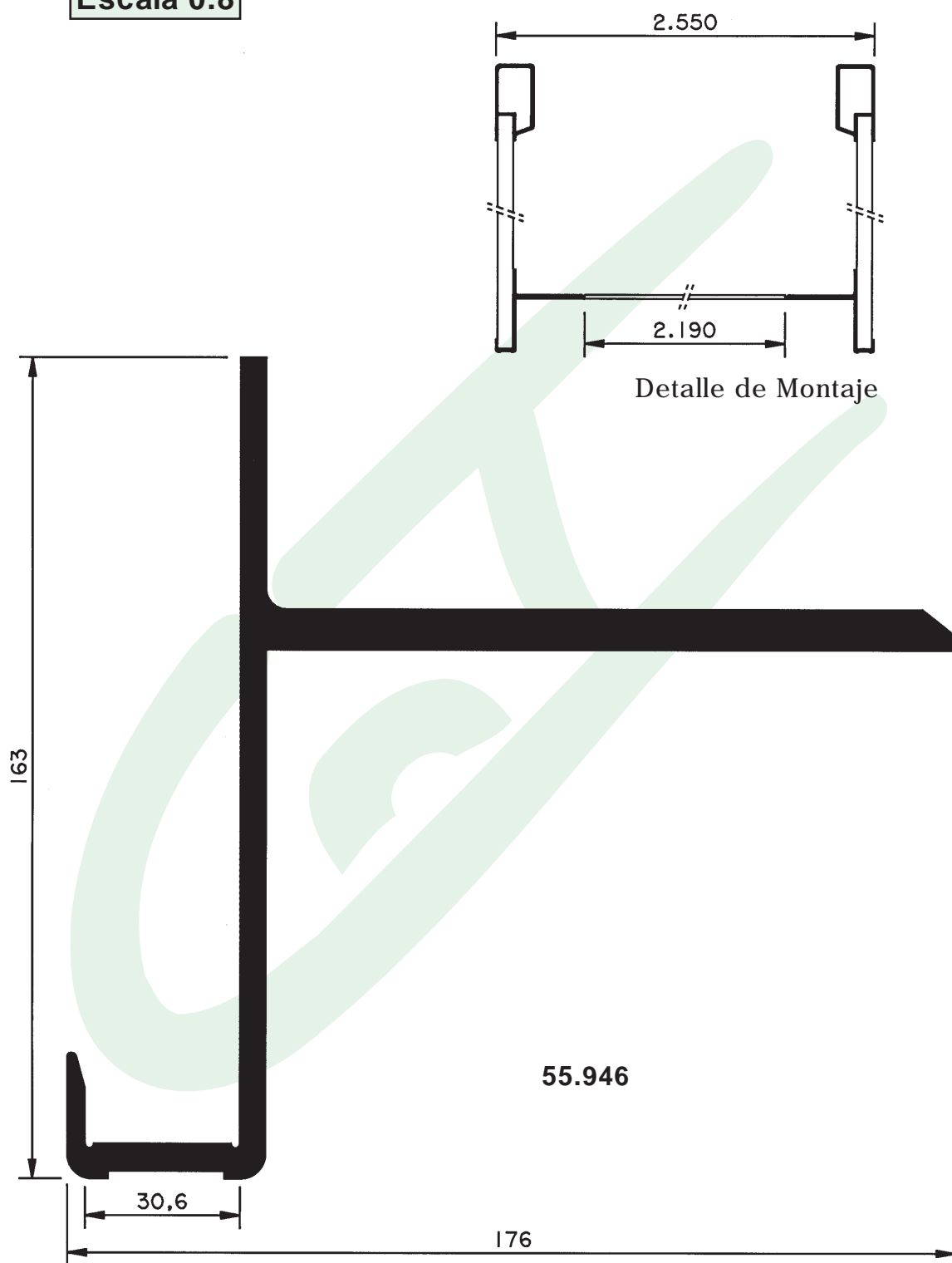

REF. ^a	DENOMINACIÓN	KGR./MT.	LONG. STOCK
55.946	Cercos Inferiores Volq. Cerealero	5,938	12.500

Escala 0.8

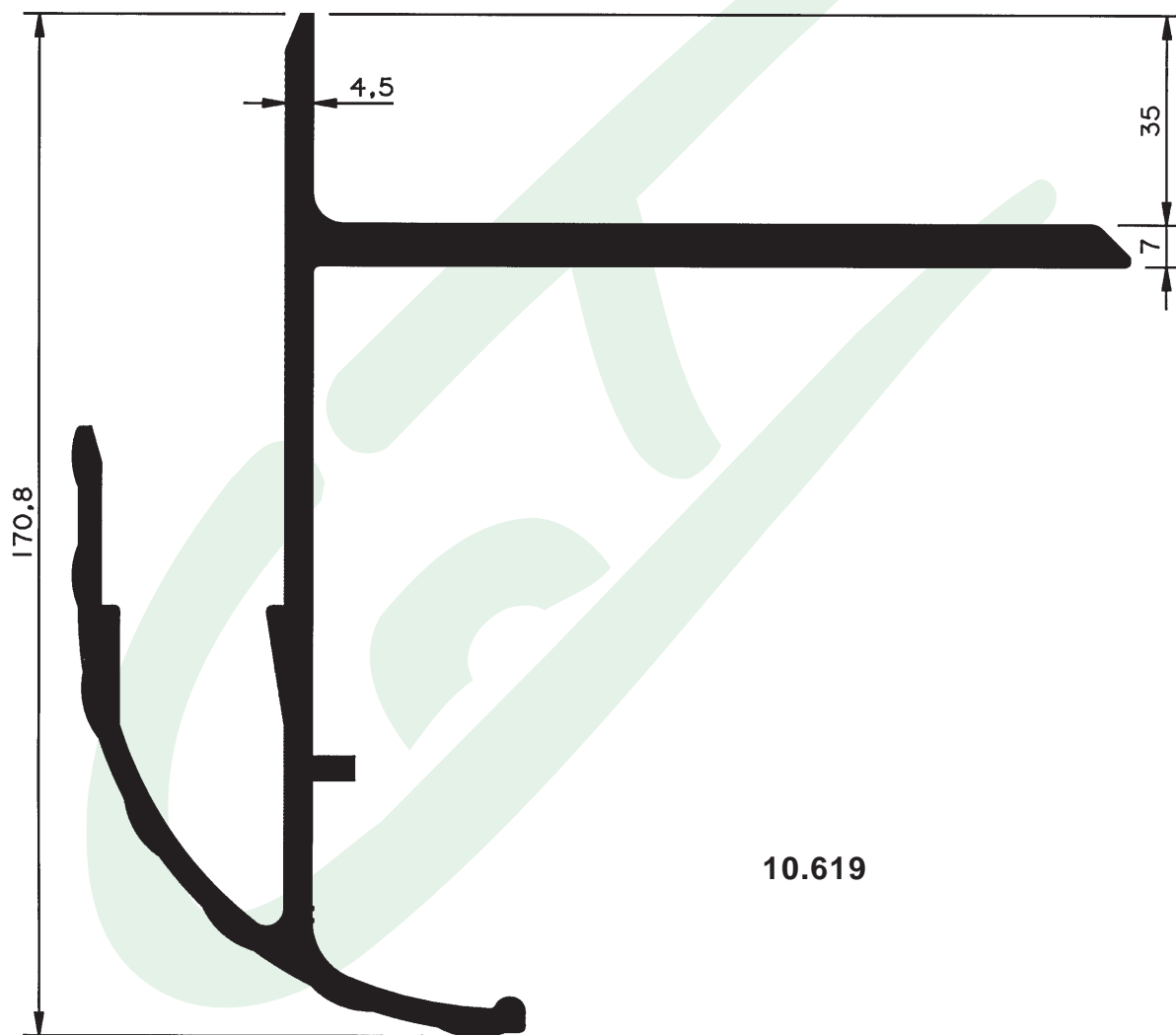

REF. ^a	DENOMINACIÓN	KGR./MT.	LONG. STOCK
10.619	Cerco Inf. Curvo Volq. Cerealero	6.439	12.500

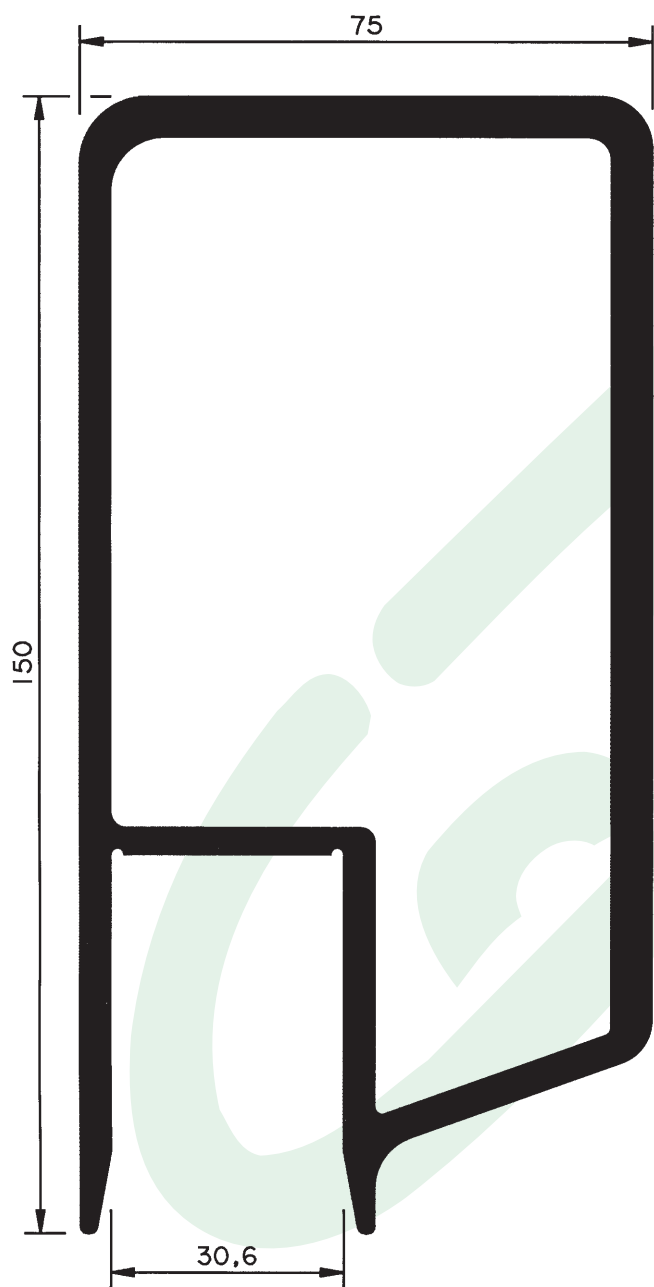

55.947



4.983

REF. ^a	DENOMINACIÓN	KGR./MT.	LONG. STOCK
55.947	Cerco Superior Volq. Cerealero	5,675	12.500
04.983	Cerco Superior Plano V. Cerealero	6,707	13.500

Escala 0.7

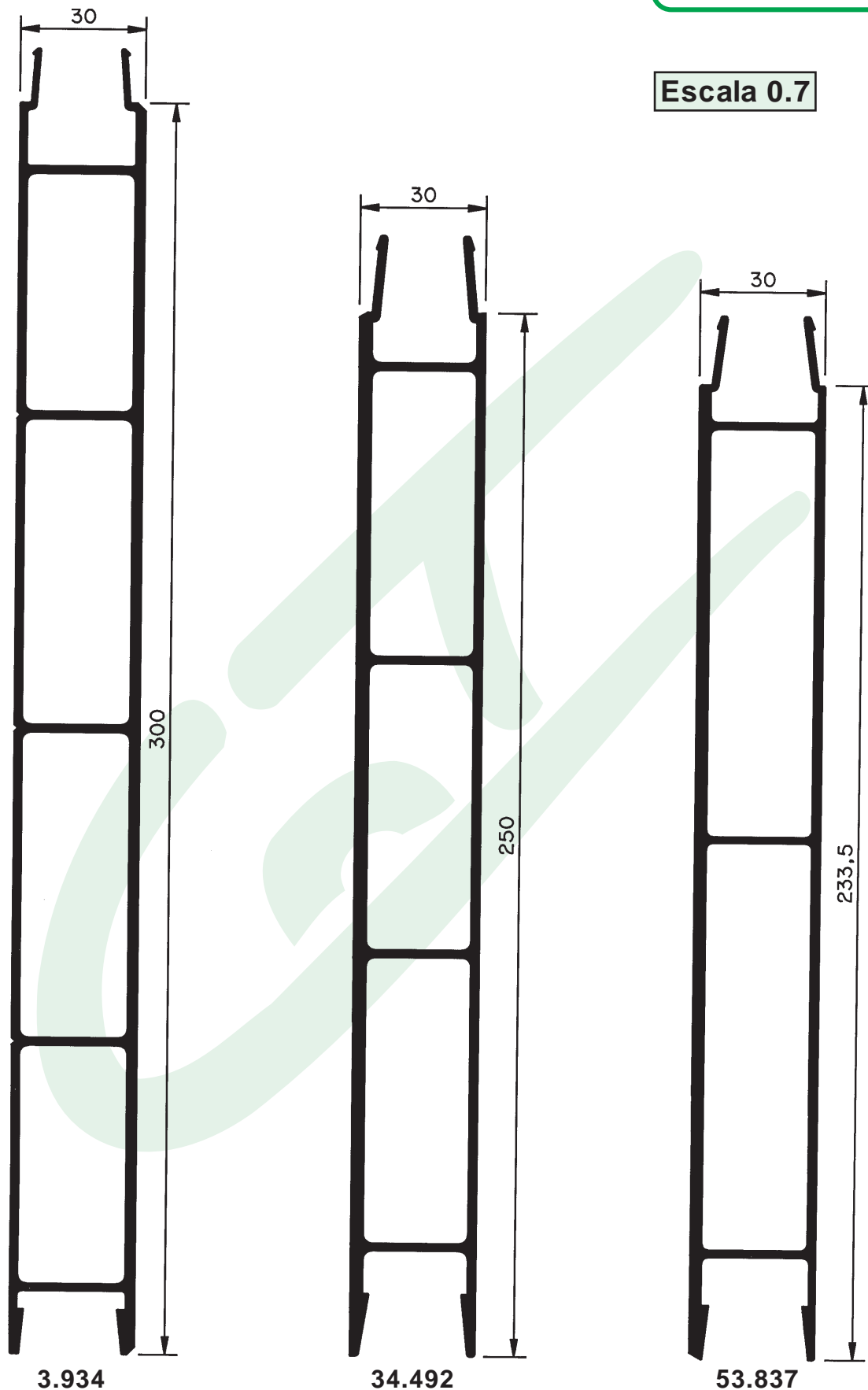

REF. ^a	DENOMINACIÓN	KGR./MT.	LONG. STOCK
03.934	Panel V-30 de 300	4,365	7.200
34.492	Panel V-30 de 250	3,857	7.200
53.837	Panel V-30 de 233,5	3,545	7.200

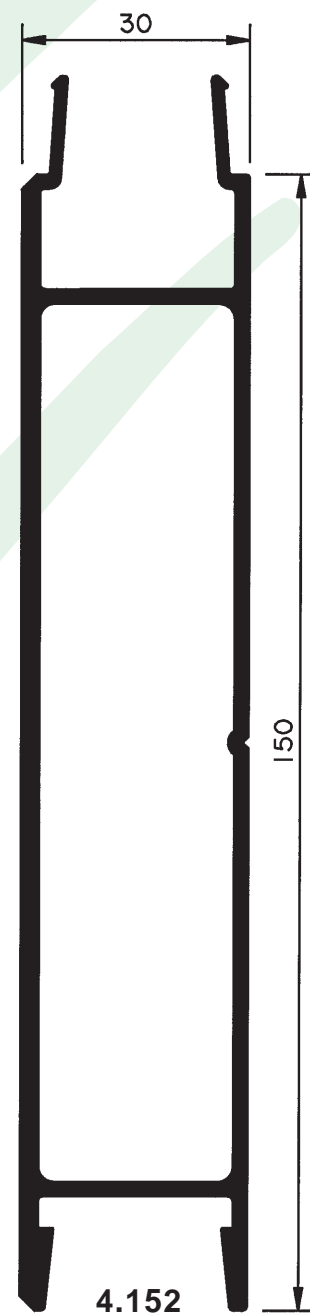
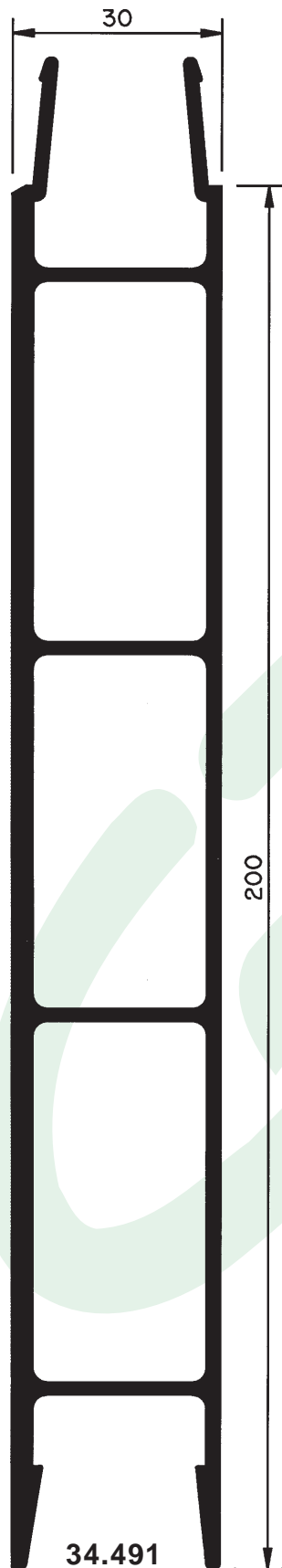

REF. ^a	DENOMINACIÓN	KGR./MT.	LONG. STOCK
34.491	Panel V-30 de 200	3,173	7.200
04.152	Panel V-30 de 150	2,216	5.500

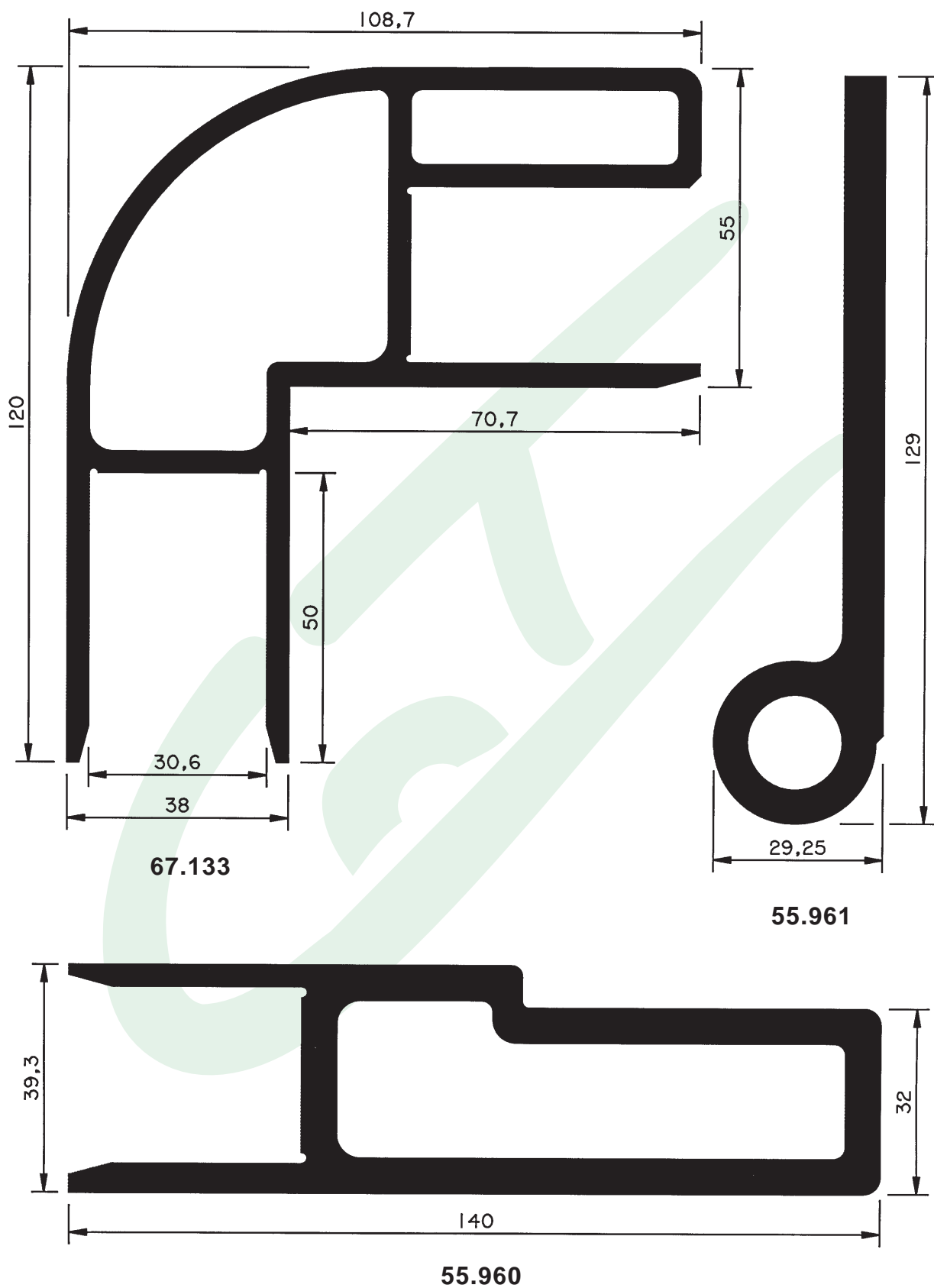

REF. ^a	DENOMINACIÓN	KGR./MT.	LONG. STOCK
67.133	Esquinero Curvo V. Cerealero	4,832	7.000
55.961	Perfil Bisagra	3,219	7.000
55.960	Perfil Remate V. Cerealero	5,049	7.000

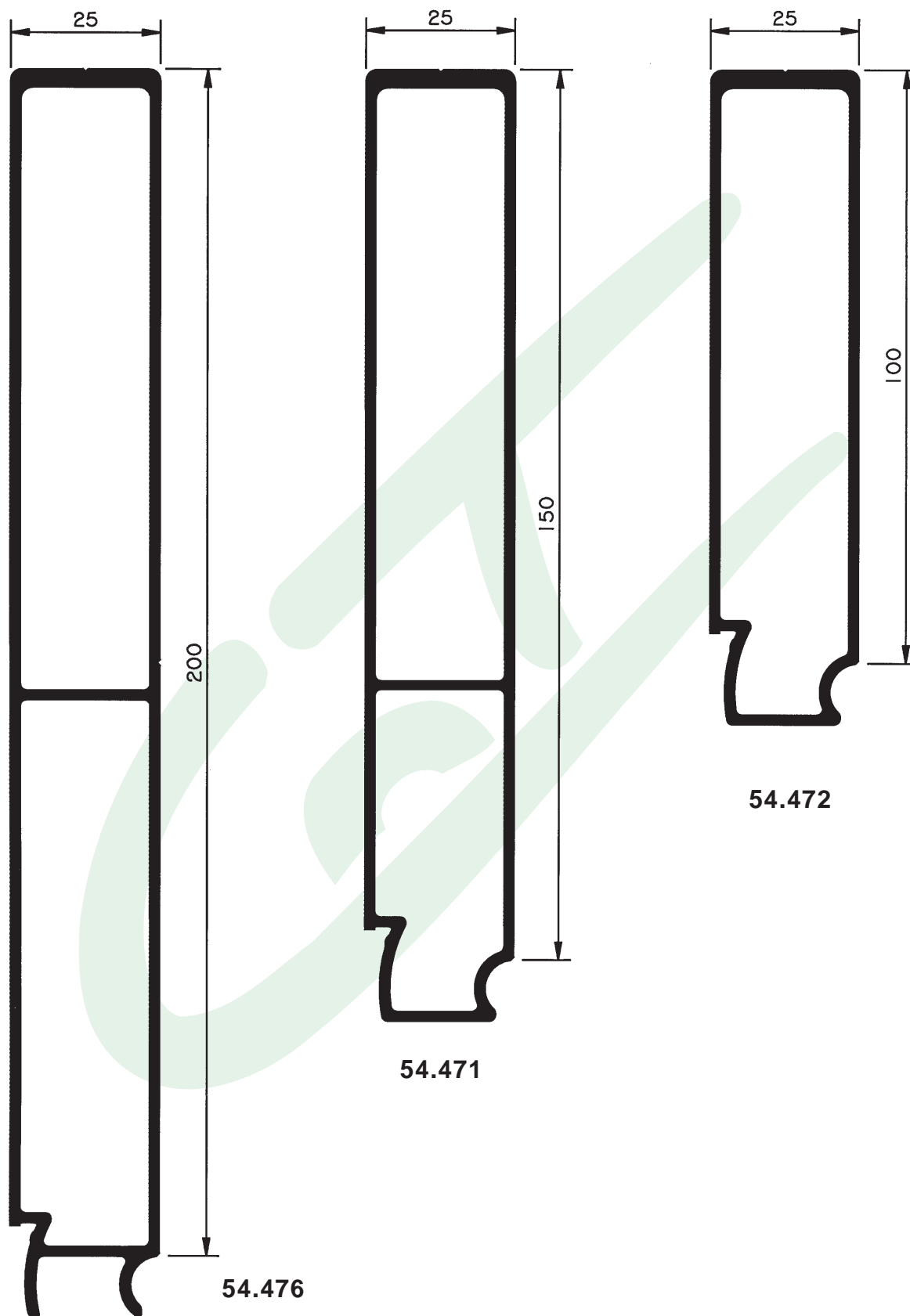

REF. ^a	DENOMINACIÓN	KGR./MT.	LONG. STOCK
54.476	Cartola Superior 200	2,213	6.300
54.471	Cartola Superior 150	1,762	6.300
54.472	Cartola Superior 100	1,245	6.300

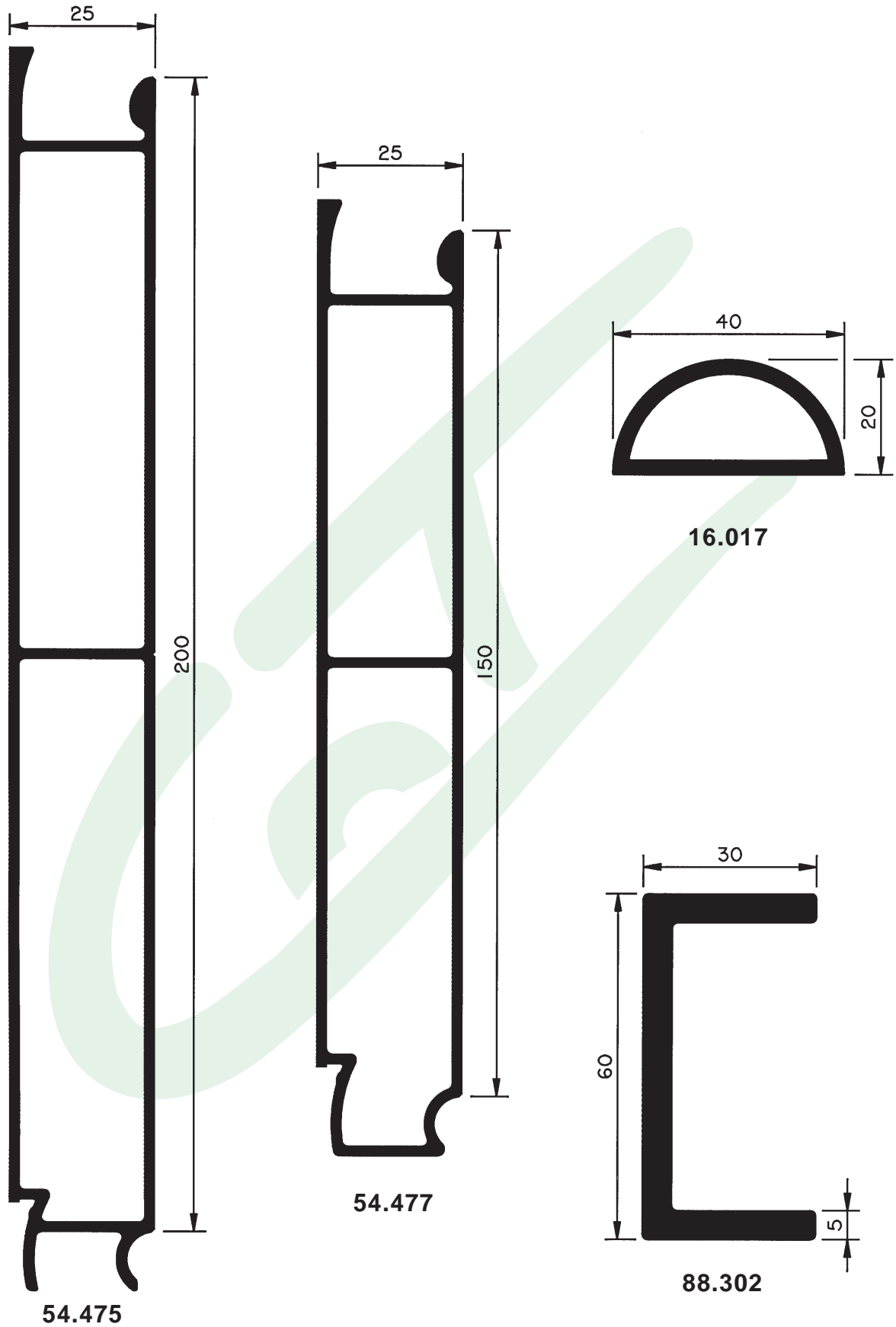

REF. ^a	DENOMINACIÓN	KGR./MT.	LONG. STOCK
54.475	Cartola Intermedia 200	2,240	6.300
54.477	Cartola Intermedia 100	1,973	6.300
16.017	Mediacaña Tubular 40 x 20	0,633	6.300
88.302	"U" de 60 x 30 x 5	1,484	6.300

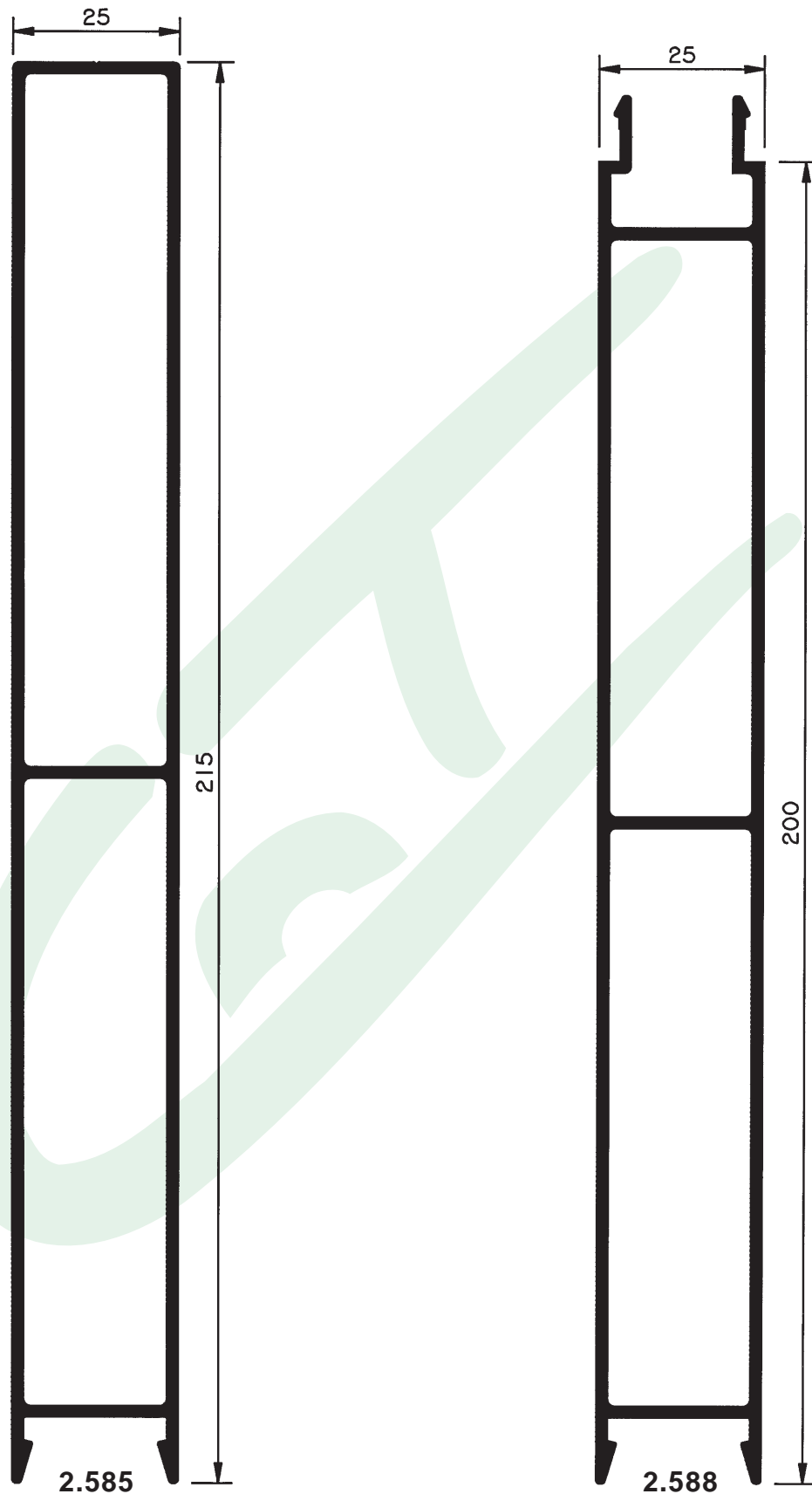

REF. ^a	DENOMINACIÓN	KGR./MT.	LONG. STOCK
02.585	Cartola Sup. 215 (Enganche Clip)	2,305	6.300
02.588	Cartola Inf. 200 (Enganche Clip)	2,285	6.300

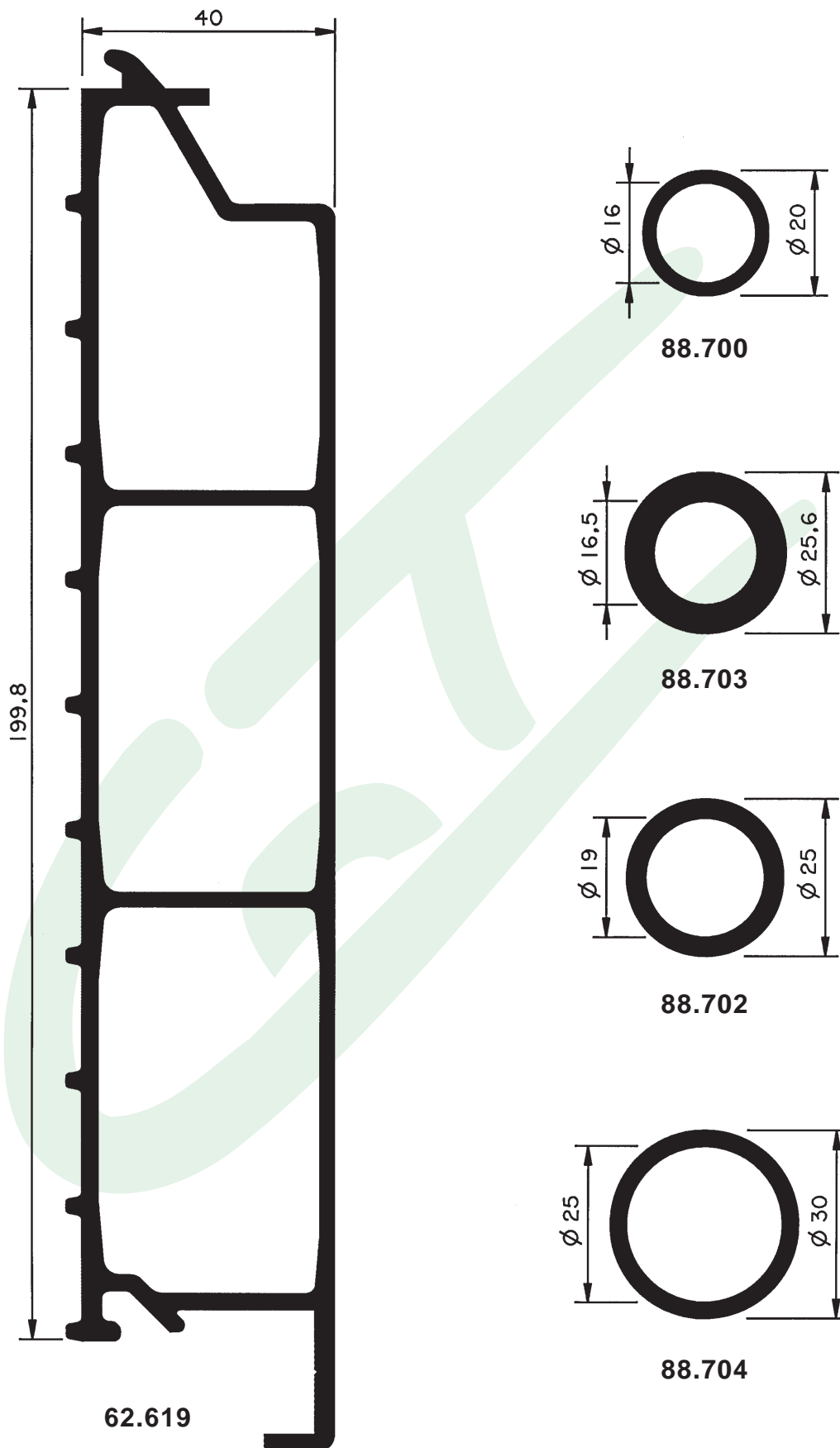

REF. ^a	DENOMINACIÓN	KGR./MT.	LONG. STOCK
62.619	Piso Ganadero	4,136	7.000 / 6.400
88.700	Tubo Redondo 20 x 2	0,305	6.000
88.703	Tubo Redondo 25,6 x 4,55	0,812	6.000
88.702	Tubo Redondo 25 x 3	0,562	6.000
88.704	Tubo Redondo 30 x 2,5	0,585	6.000

Escala 0.8

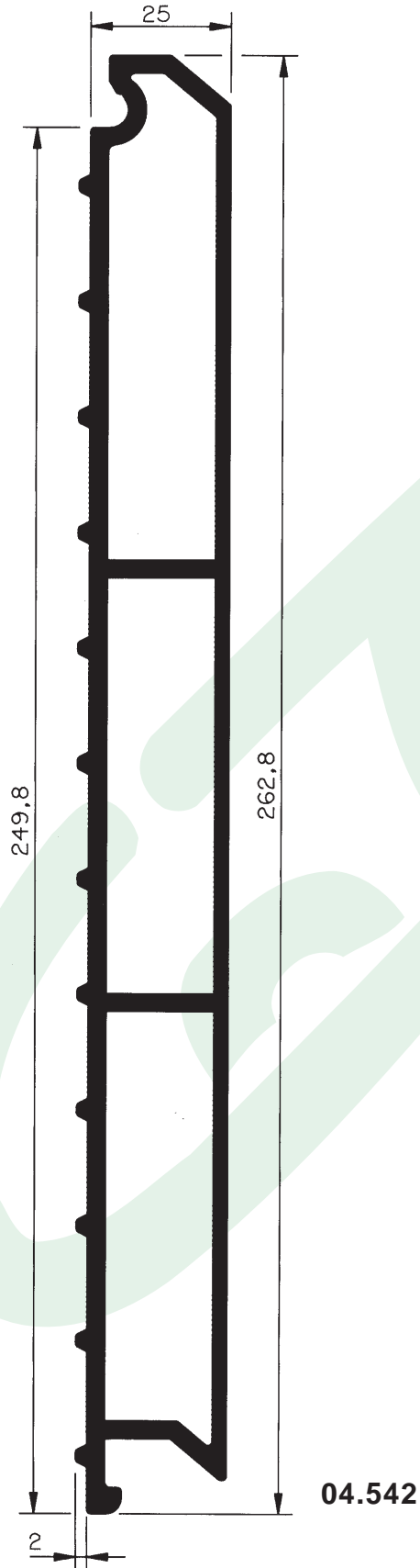

Acoplamiento

REF. ^a	DENOMINACIÓN	KGR./MT.	LONG. STOCK
04.542	Piso Ganadero de 250 mm.	4,998	7.000 / 6.400

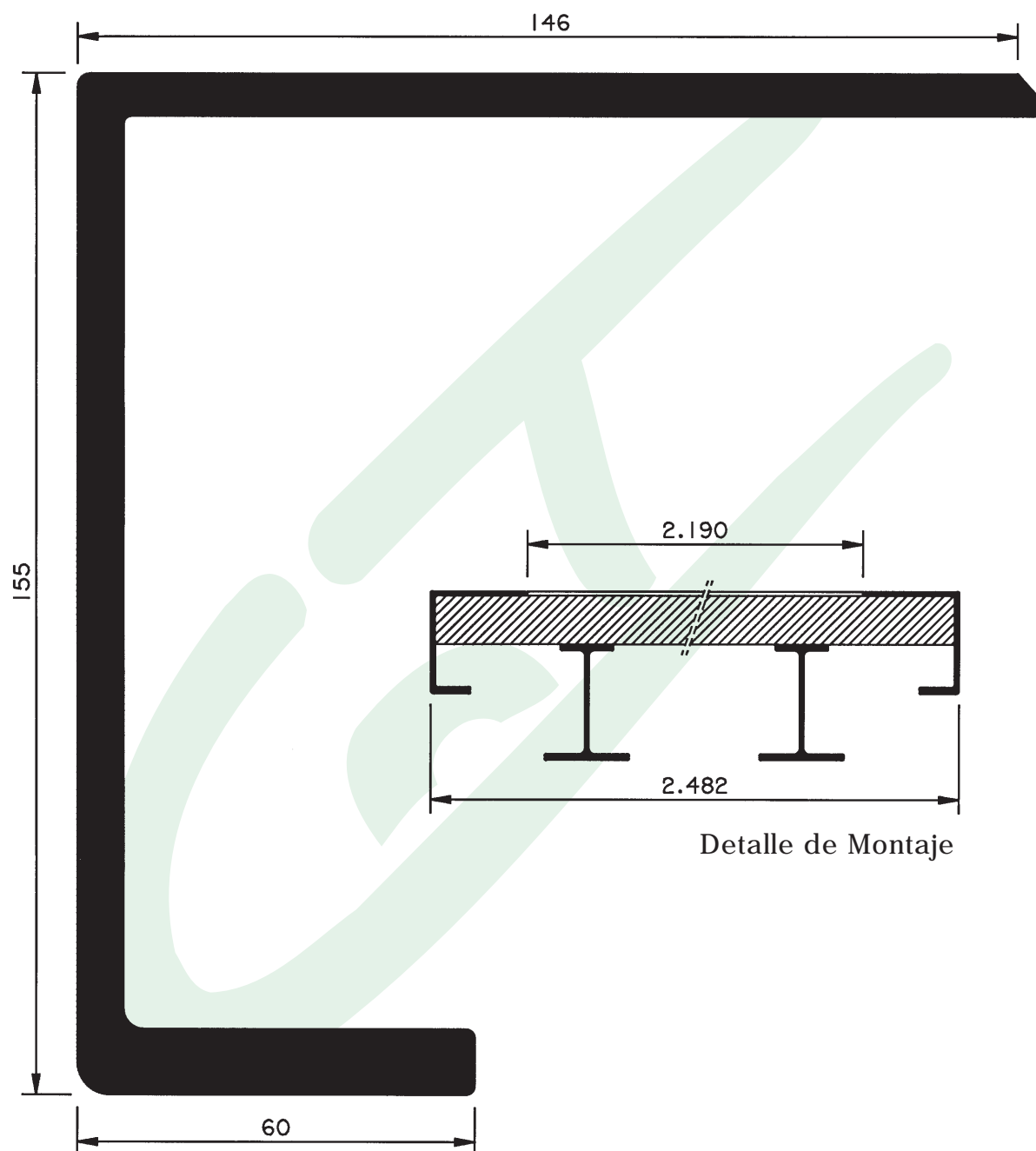

56.866

REF. ^a	DENOMINACIÓN	KGR./MT.	LONG. STOCK
56.866	Cerco Plataforma 146	6,796	12.600

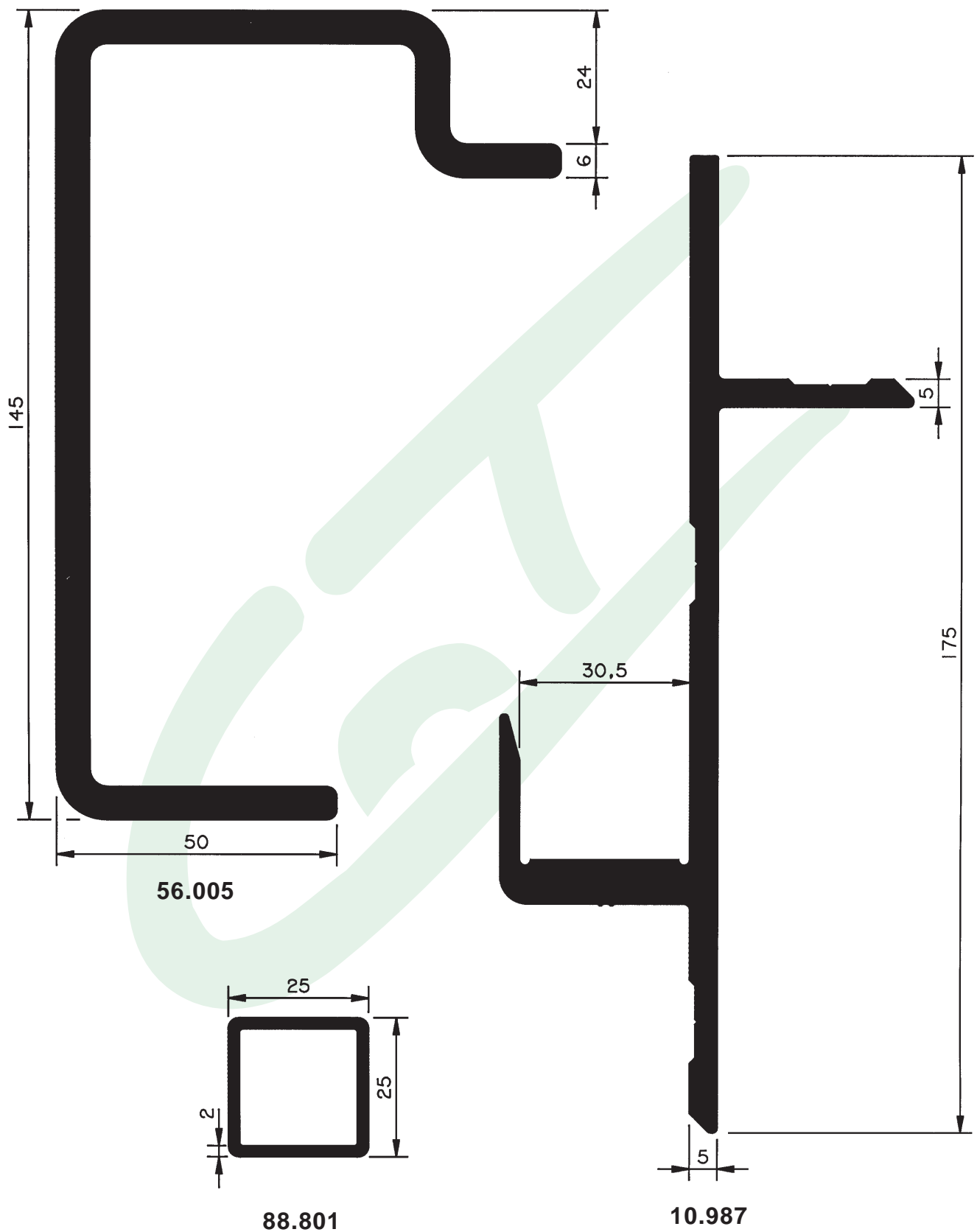

REF. ^a	DENOMINACIÓN	KGR./MT.	LONG. STOCK
56.005	Cerco Tablero	4,748	7.000
10.987	Cerco Piso Móvil	3,725	7.000
88.801	Tubo Cuad. 25 x 2	0,496	6.000

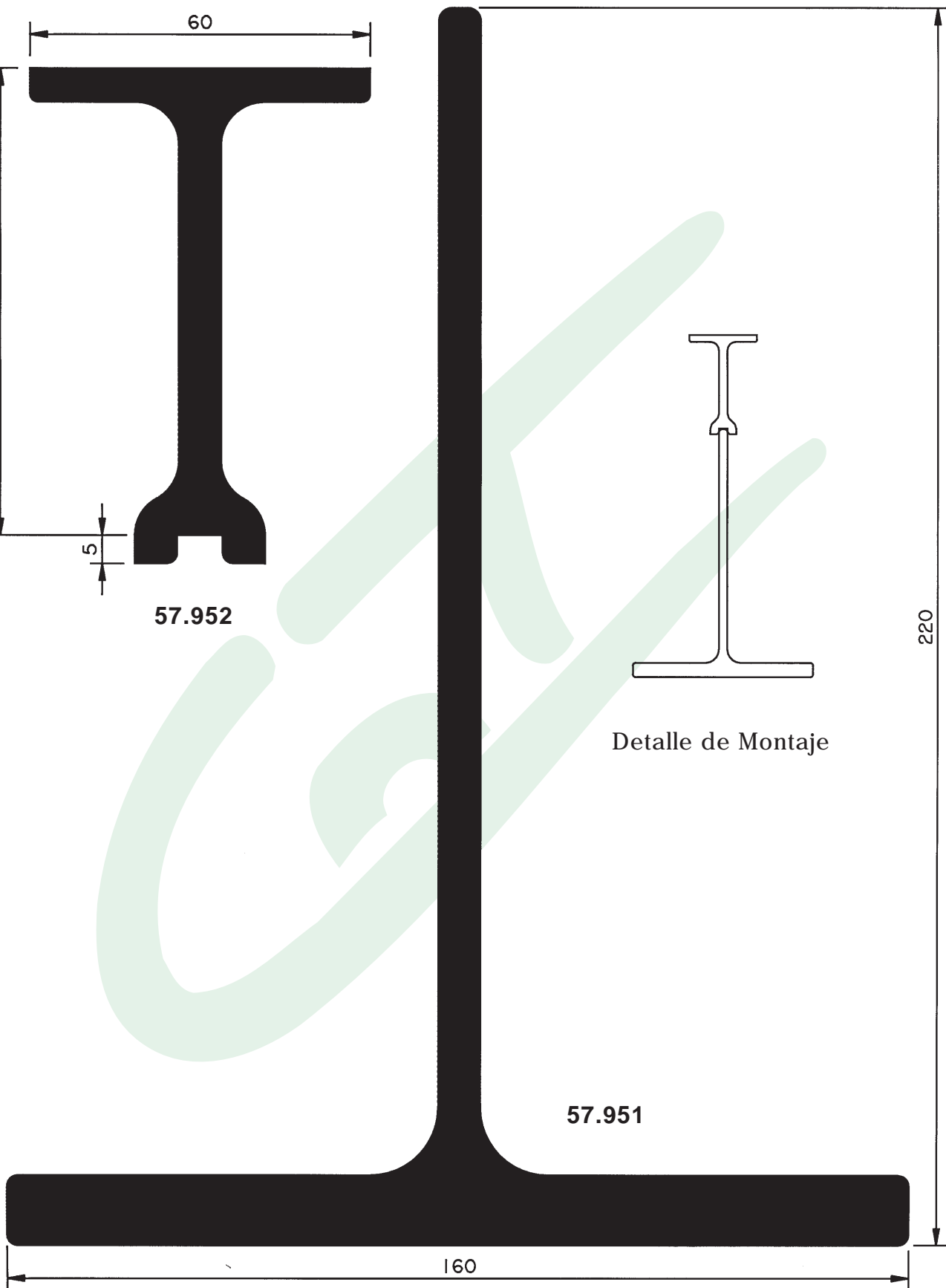
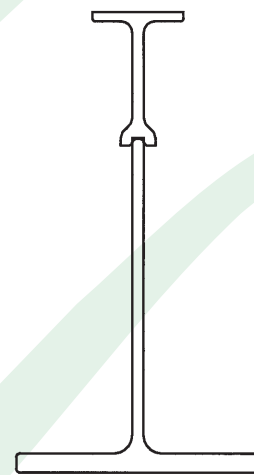
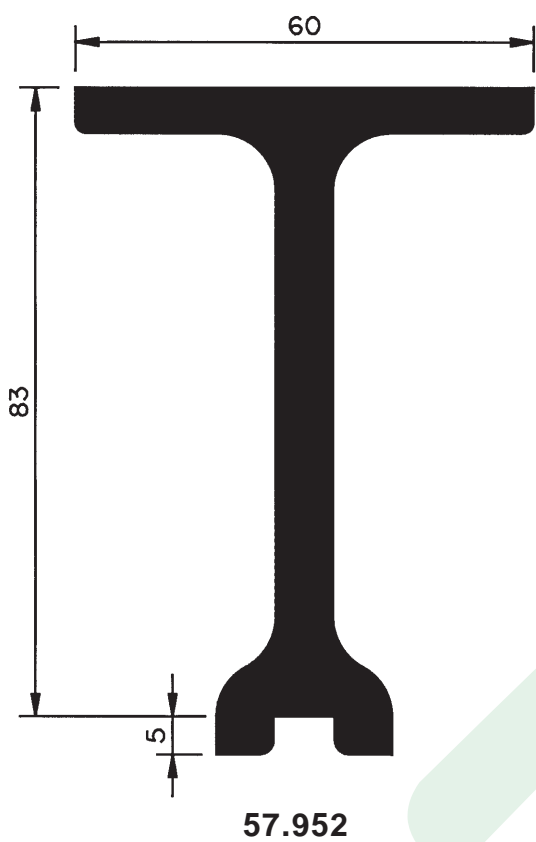

REF. ^a	DENOMINACIÓN	KGR./MT.	LONG. STOCK
57.951	"T" 160 x 220 De Empuje	9,792	12.600
57.952	"T" 83 x 60 De Unión	3,079	7.000

Escala 0.8

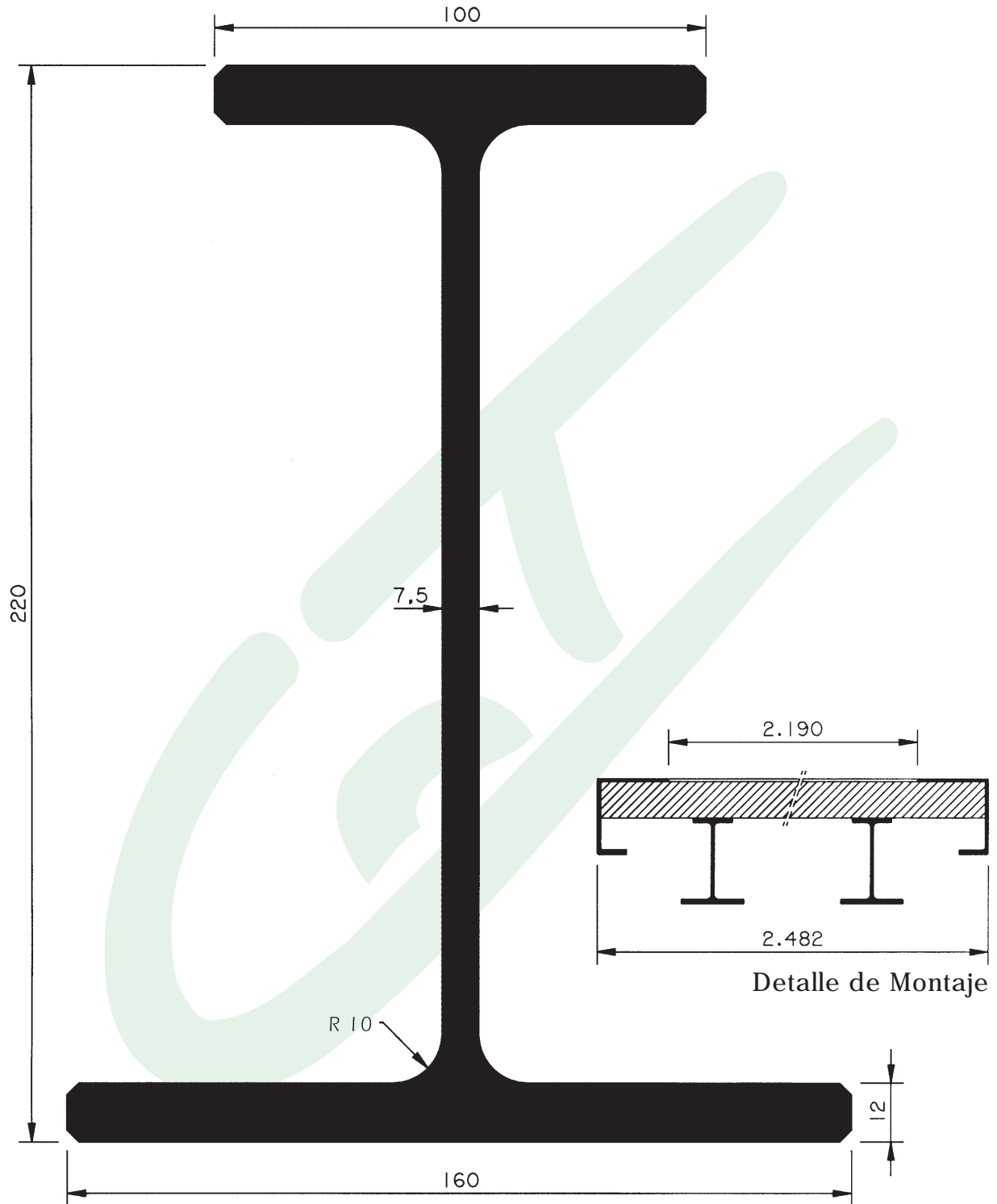

75.089

REF. ^a	DENOMINACIÓN	KGR./MT.	LONG. STOCK
75.049	Doble "T" Desigual Empuje	12,931	12.600

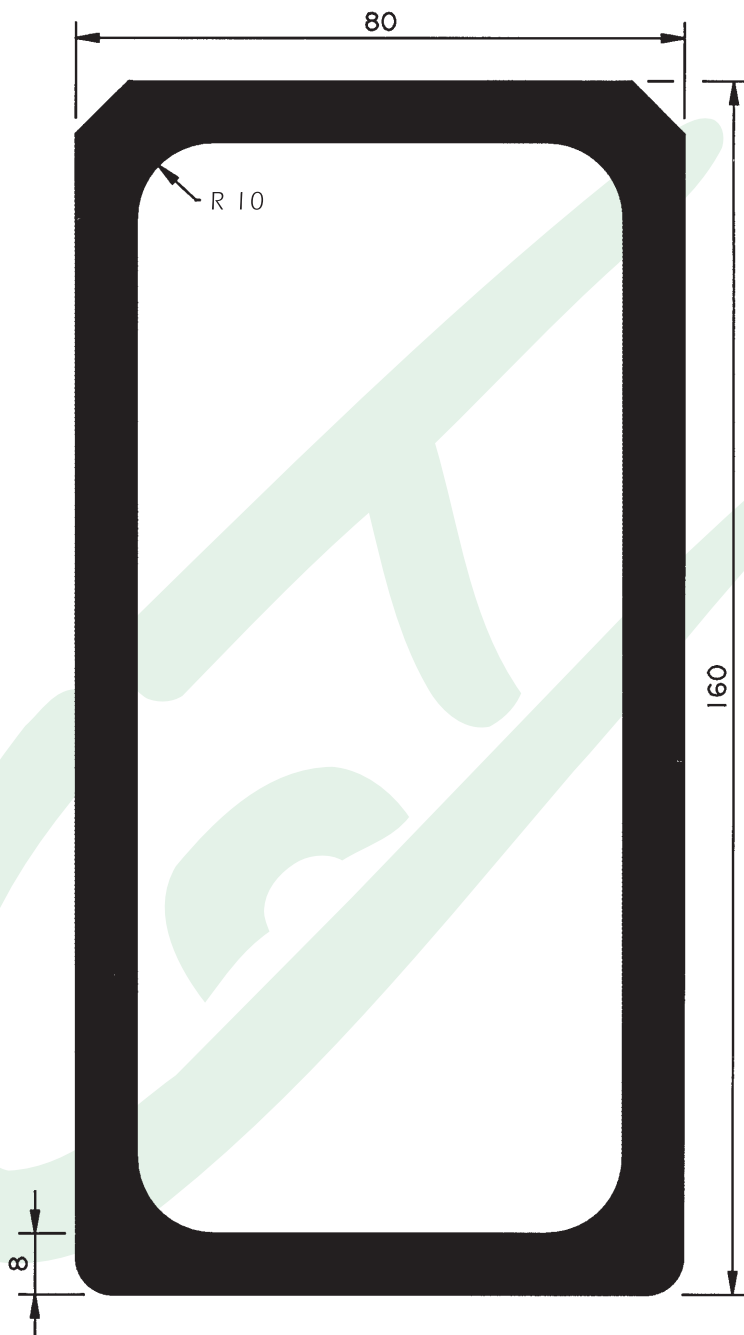

4.020

REF. ^a	DENOMINACIÓN	KGR./MT.	LONG. STOCK
04.020	Tubo Empuje	9,784	12.500

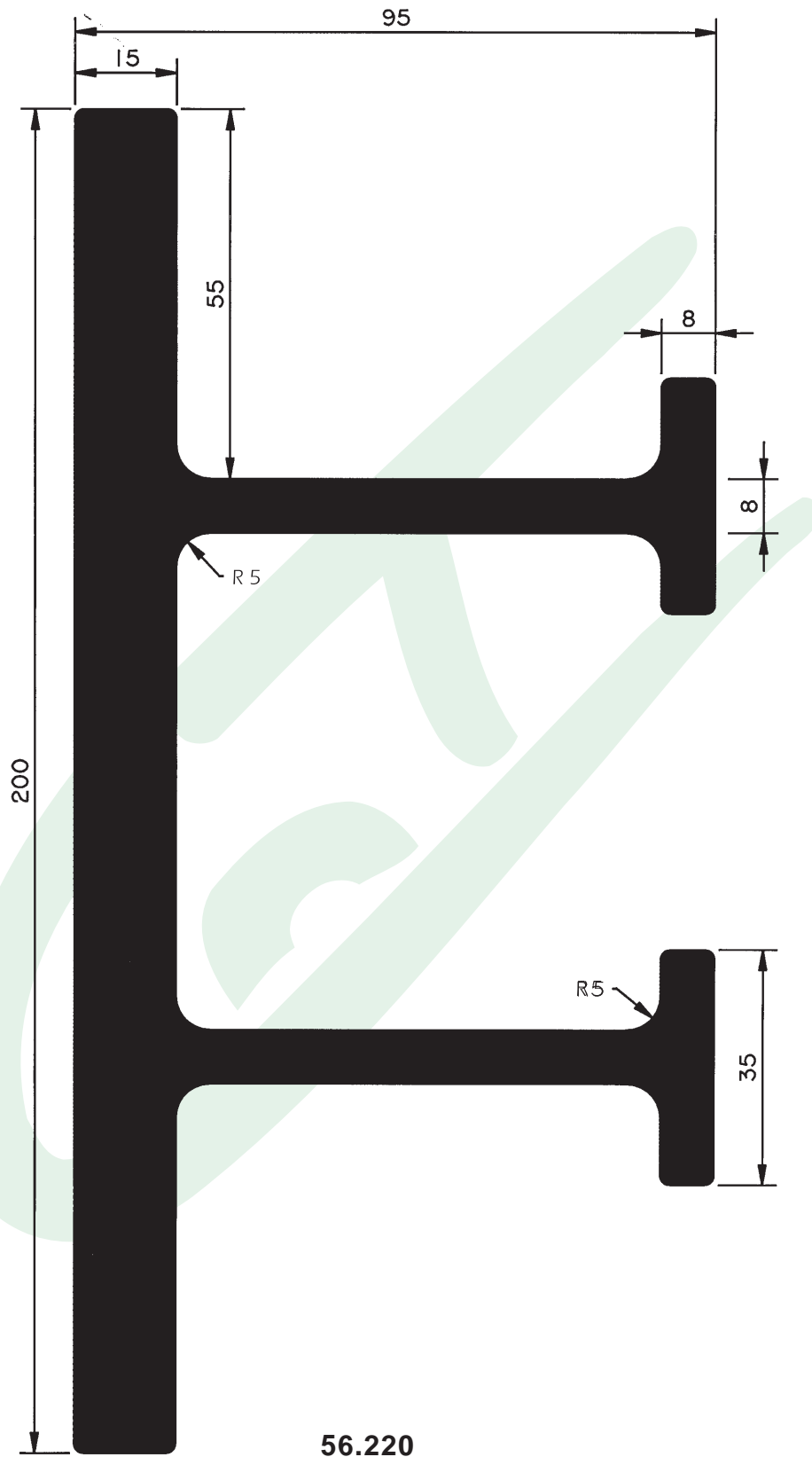

REF. ^a	DENOMINACIÓN	KGR./MT.	LONG. STOCK
56.220	Refuerzo de Basculante	12,850	6.000

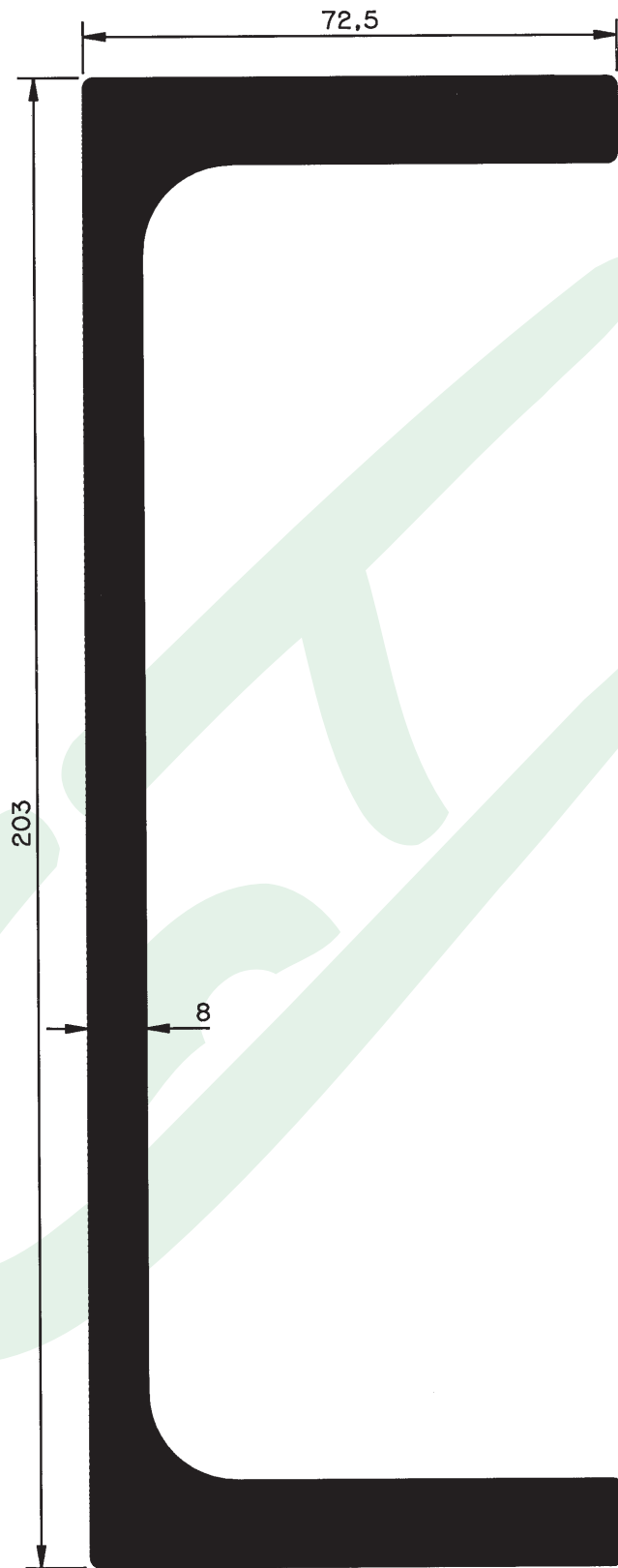

3.797

REF. ^a	DENOMINACIÓN	KGR./MT.	LONG. STOCK
03.797	"U" 203 x 72,5	8,638	7.000

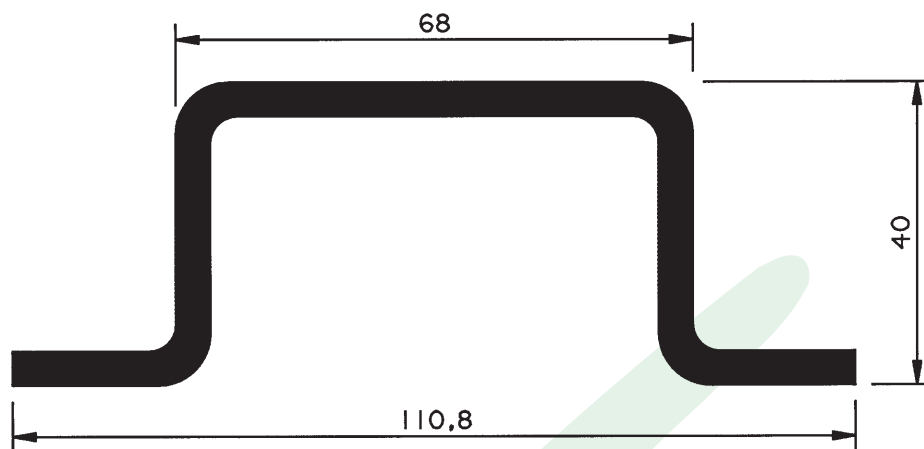

41.034

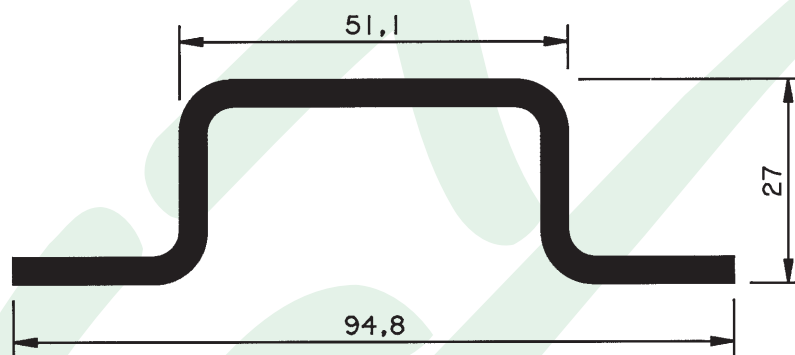

41.459



88.710

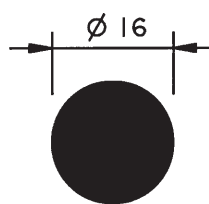

88.104

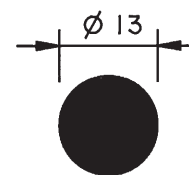

88.102

REF. ^a	DENOMINACIÓN	KGR./MT.	LONG. STOCK
41.034	Omega 110,8	1,987	7.000
41.459	Omega 94,8	1,224	7.000
88.710	Tubo Red. 50 x 5	1,916	6.000
88.104	Redondo 16	0,543	6.000
88.102	Redondo 13	0,358	6.000

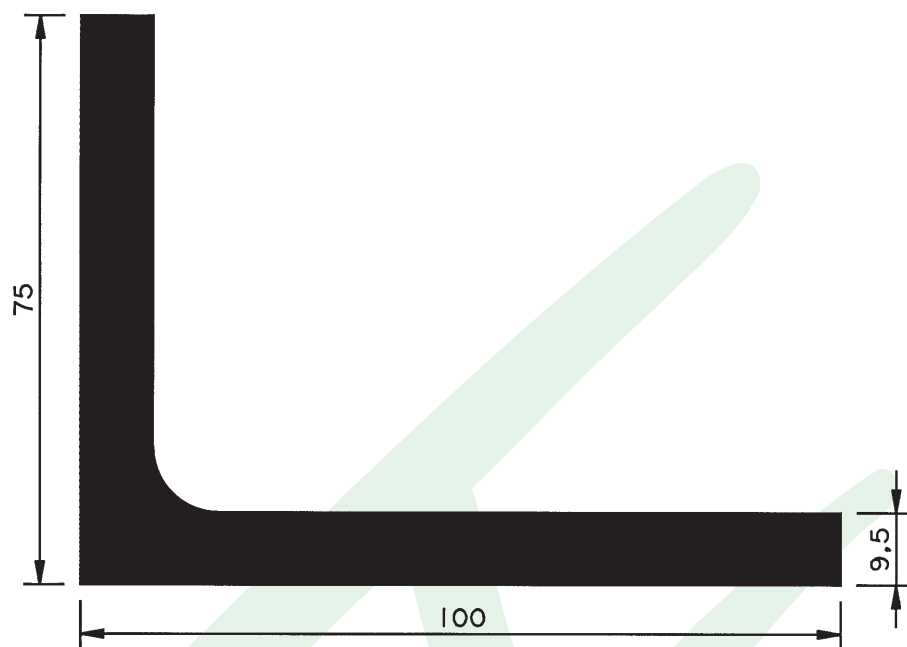

50.232

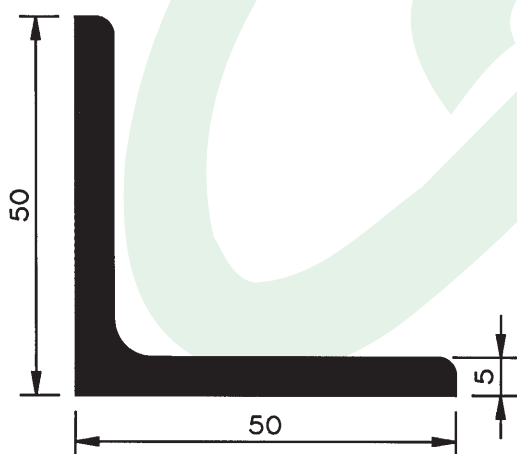

88.404

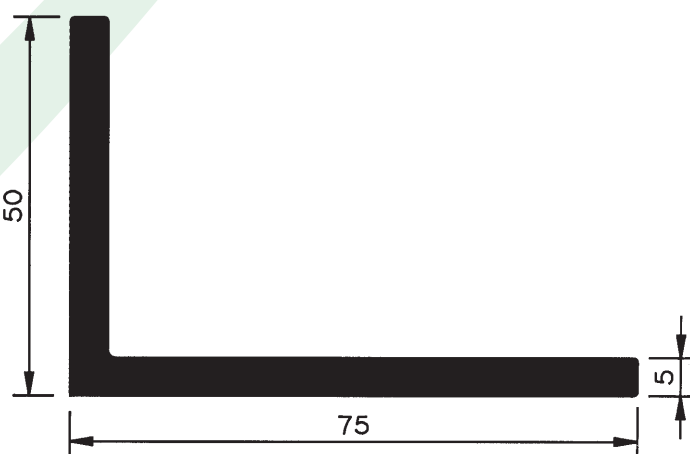

88.502

REF. ^a	DENOMINACIÓN	KGR./MT.	LONG. STOCK
50.232	Ángulo 100 x 75 x 9,5	4,207	7.000
88.404	Ángulo 50 x 50 x 5	1,294	6.000
88.502	Ángulo 75 x 50 x 5	1,614	6.000

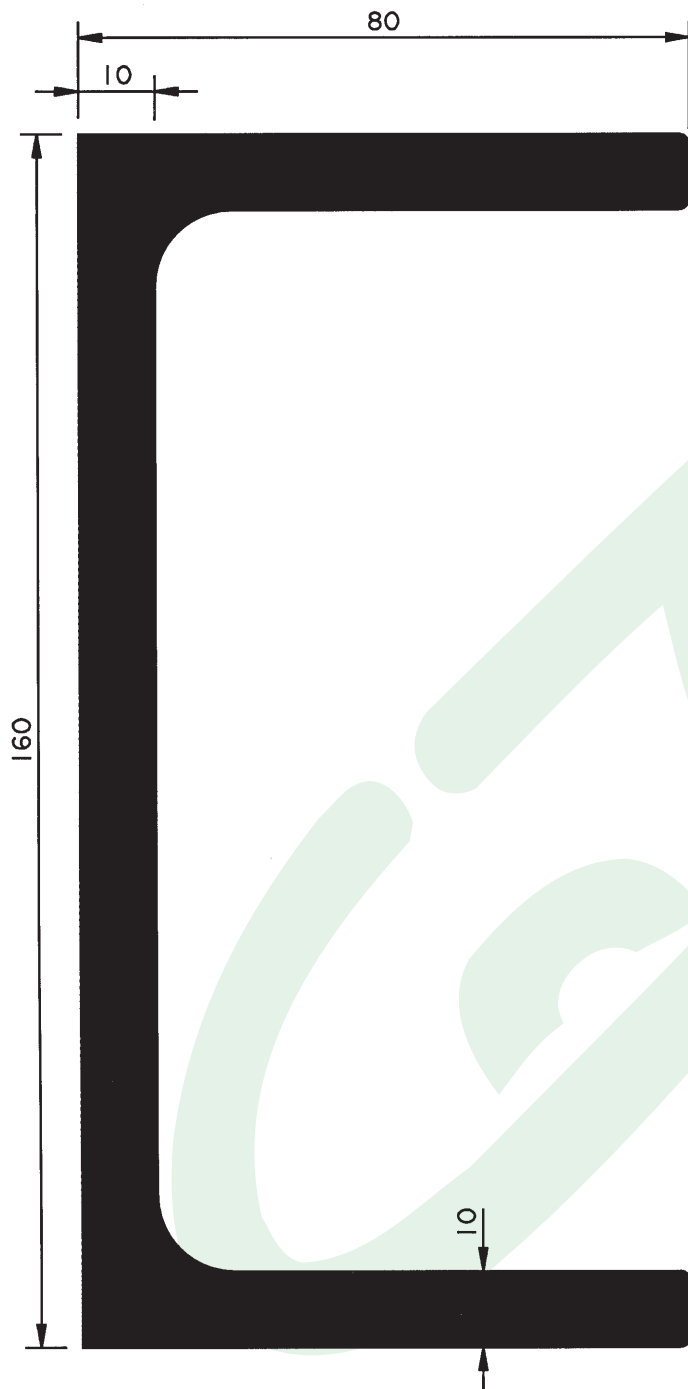

51.537

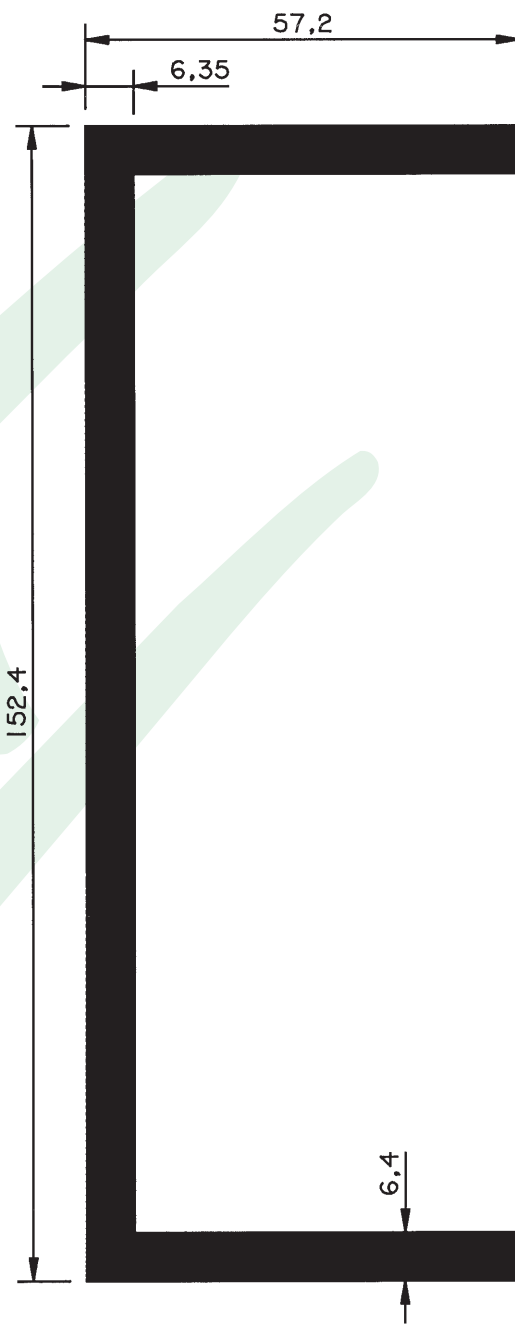

51.890

REF. ^a	DENOMINACIÓN	KGR./MT.	LONG. STOCK
51.537	"U" 160 x 80 x 10	8,244	12.500
51.890	"U" 152,4 x 57,2	4,373	7.000



75.043

REF. ^a	DENOMINACIÓN	KGR./MT.	LONG. STOCK
75.043	"U" 200 x 100 x 12	12,200	12.500

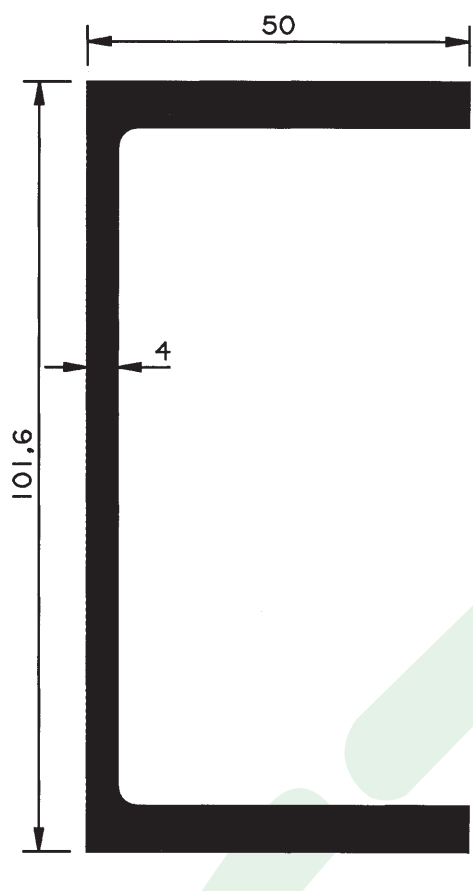

88.304

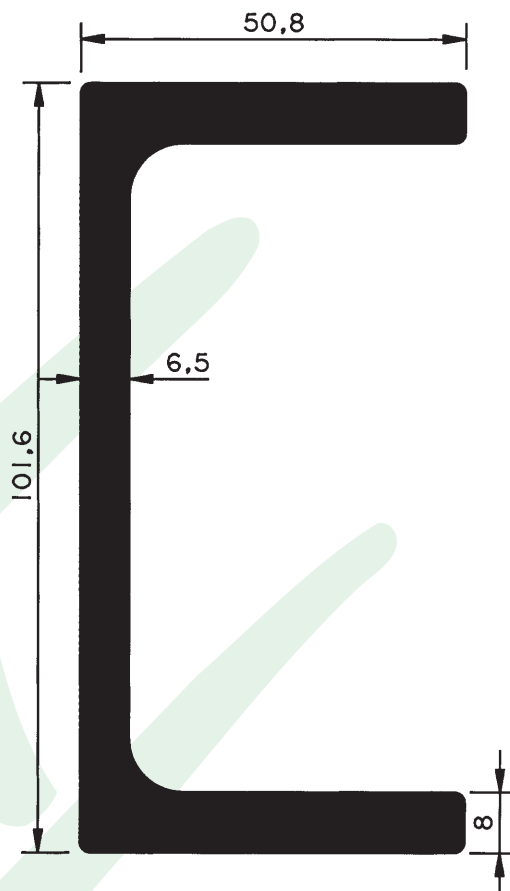

40.539

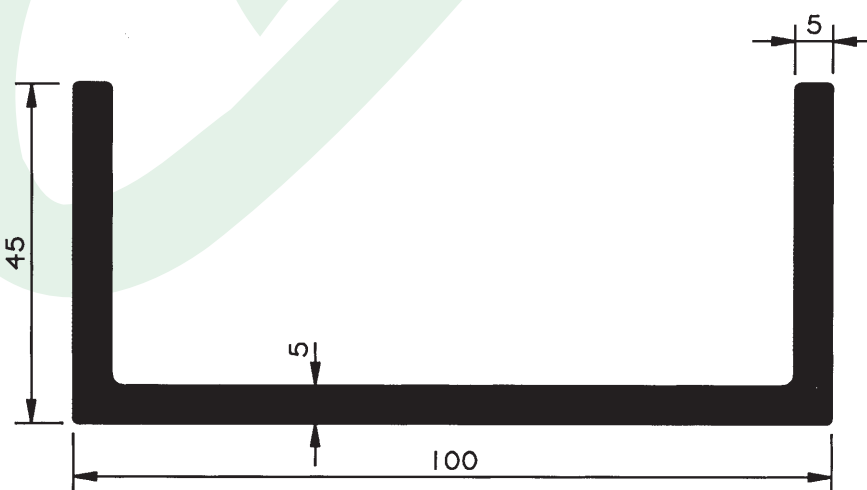

88.303

REF. ^a	DENOMINACIÓN	KGR./MT.	LONG. STOCK
88.304	"U" 101,6 x 50	2,607	6.000
40.339	"U" 101,6 x 50,8	3,754	7.000
88.303	"U" 100 x 45	2,424	6.000

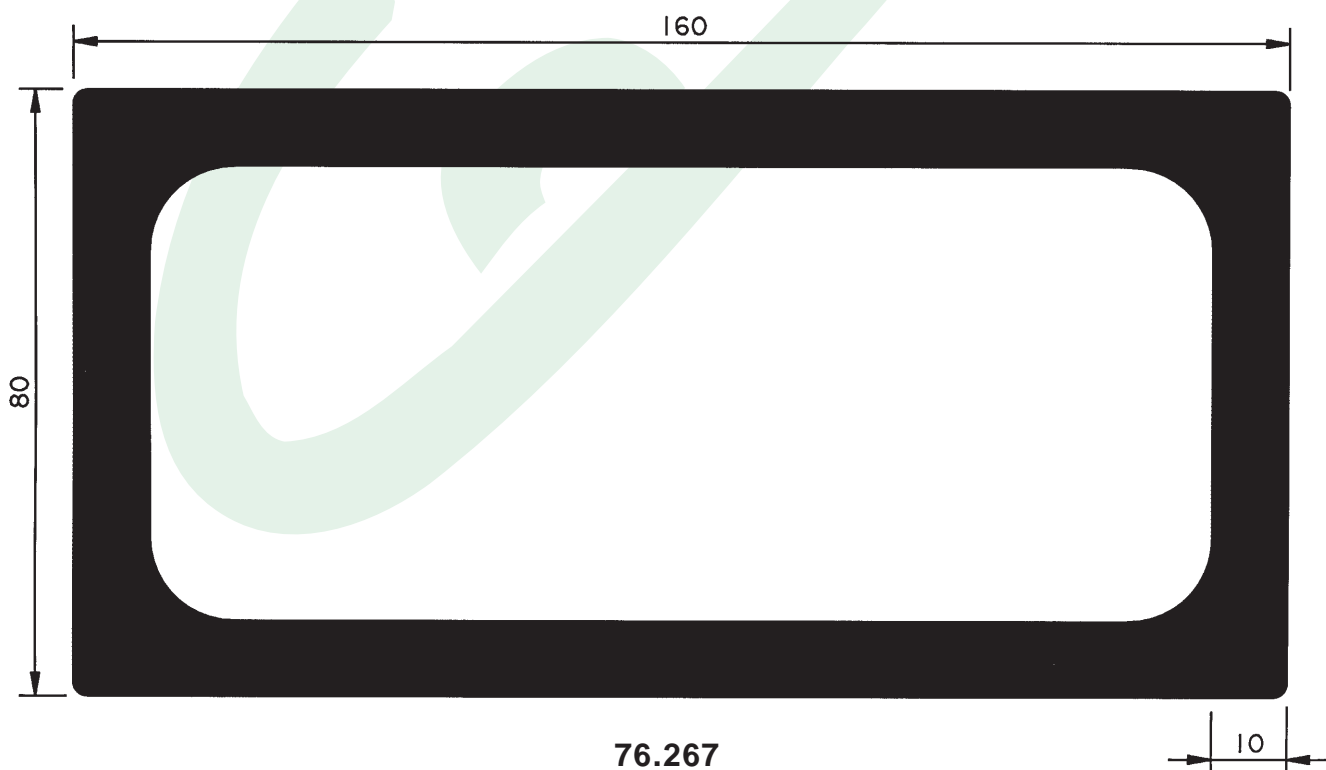
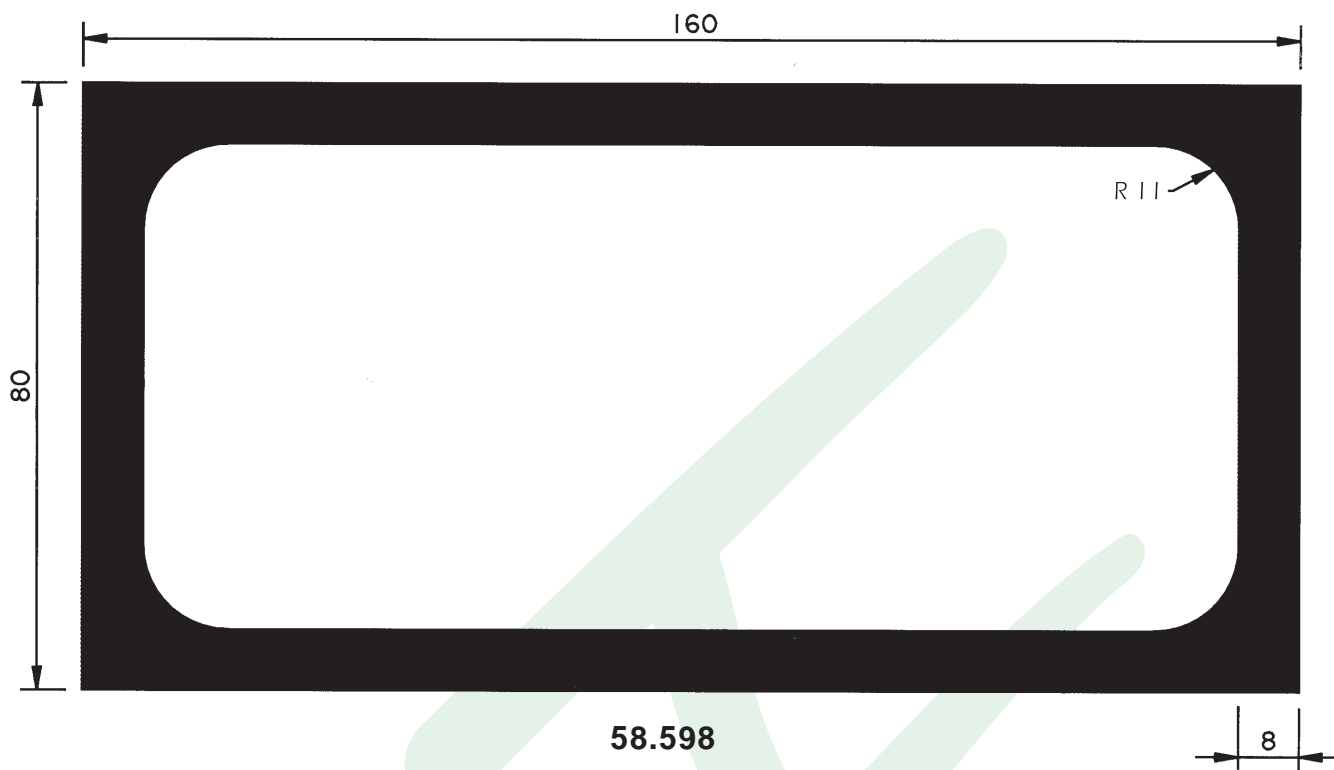

REF. ^a	DENOMINACIÓN	KGR./MT.	LONG. STOCK
58.598	Tubo Rectangular 160 x 80 x 8	9,957	12.500
76.267	Tubo Rectangular 160 x 80 x 10	12,150	12.500

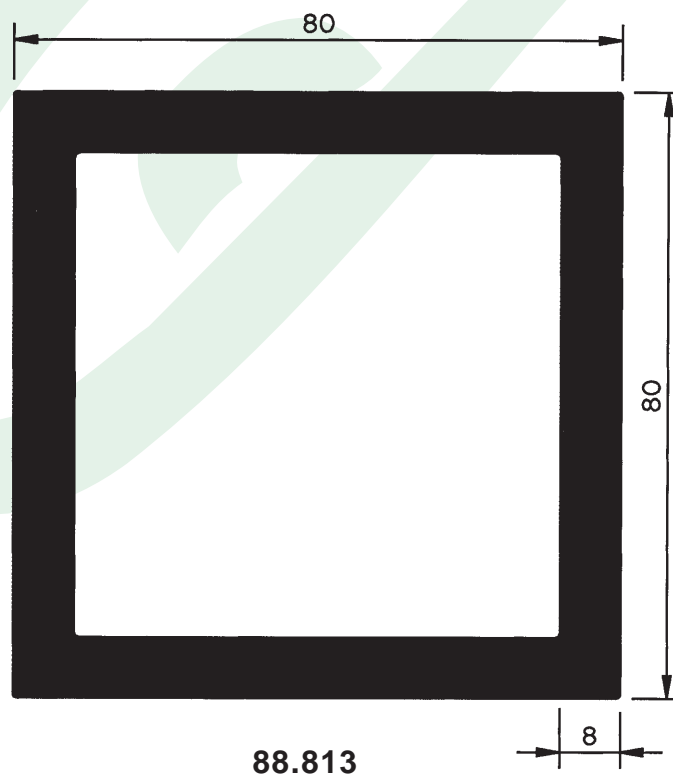
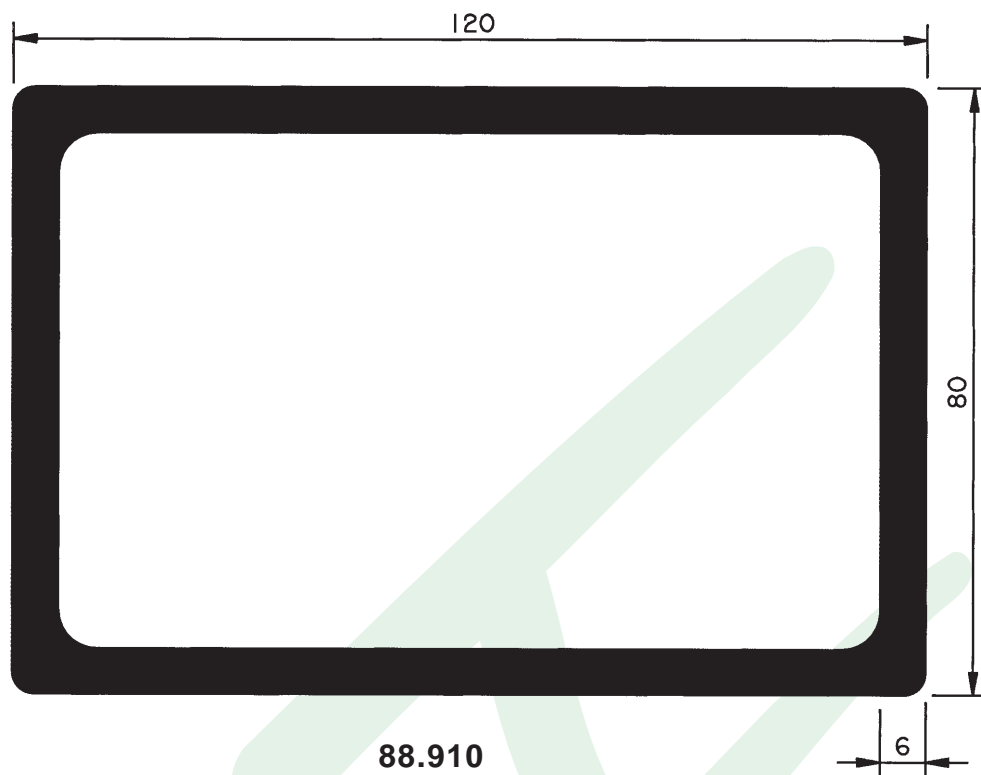

REF. ^a	DENOMINACIÓN	KGR./MT.	LONG. STOCK
88.910	Tubo Rectangular 120 x 80 x 6	6,128	6.000
88.813	Tubo Cuadrado 80 x 8	6,221	6.000

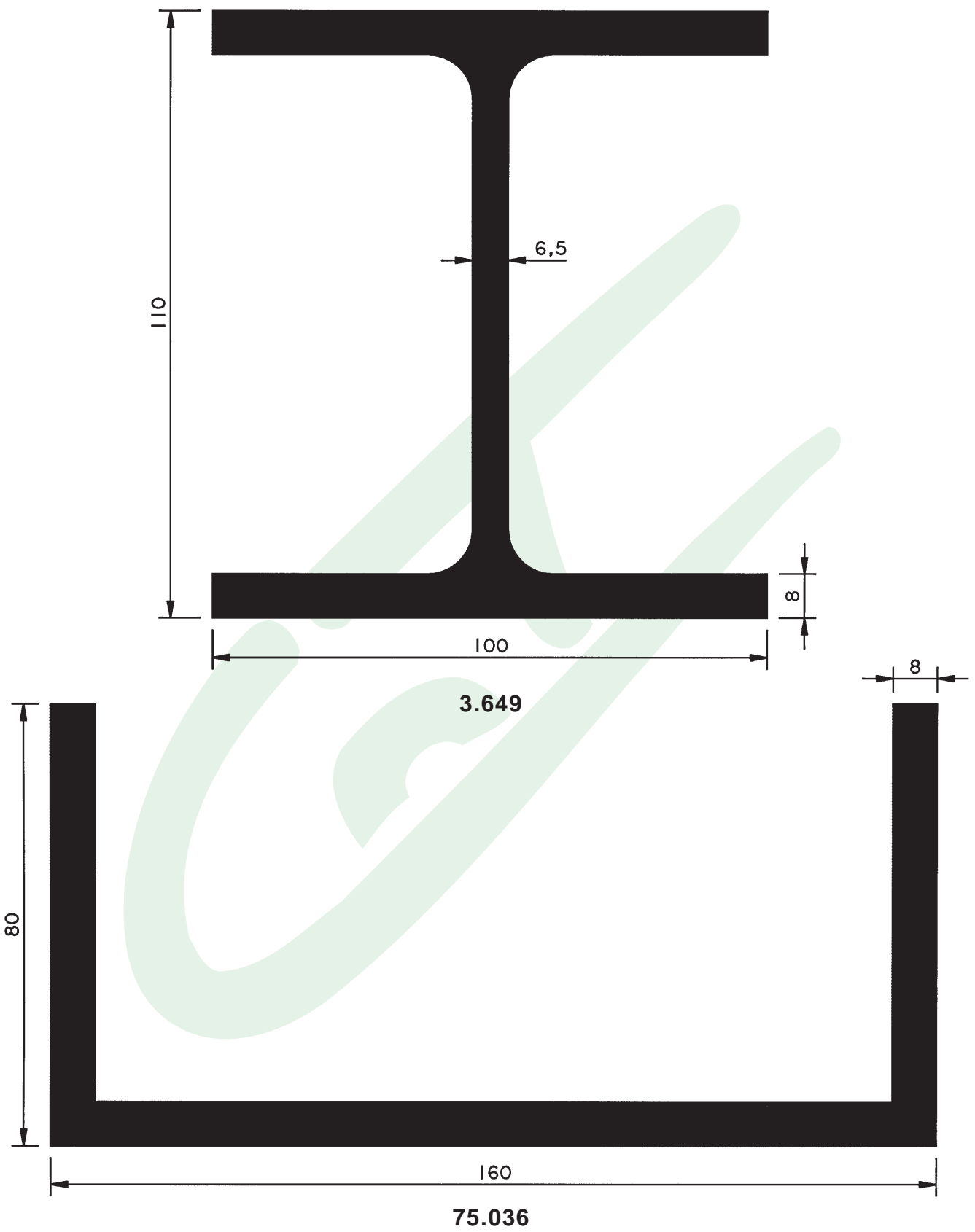

REF. ^a	DENOMINACIÓN	KGR./MT.	LONG. STOCK
03.649	Doble "T" 100 x 100	6,225	6.000
75.036	"U" 160 x 80 x 8	6,730	7.000