



**sistemas
continental**
aluminio para arquitectura

MALLORQUINA CORREDERA



QUALICOAT
| SEASIDE | QUALIDECO |

af **aluminios
franco**

CARACTERISTICAS MALLORQUINA CORREDERA

- Sistema de carpintería hoja perimetral para ventanas y puertas correderas.
- Posibilidad de lama fija y lama regulable.
- Cámara europea estandar para alojamiento de herrajes.
- Sistema que permite un alto grado de protección solar y óptima visibilidad exterior.
- Posibilidad de fabricación para fachada ó forjado.
- Permite una apertura de grandes dimensiones, dejando acceder al hueco total de la ventana o puerta.
- Características que cumplen las exigencias del mercado.
- Aleación 6063 T-5.

APERTURAS

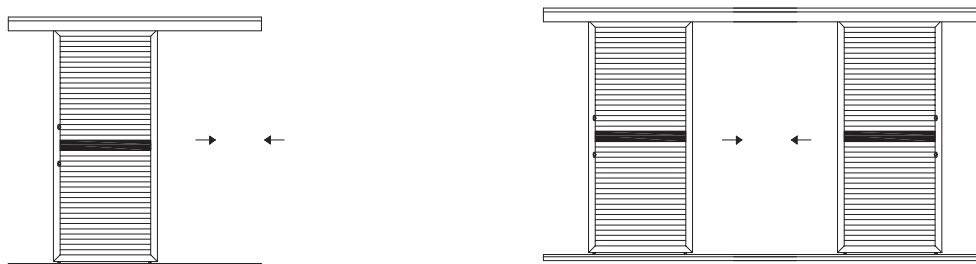

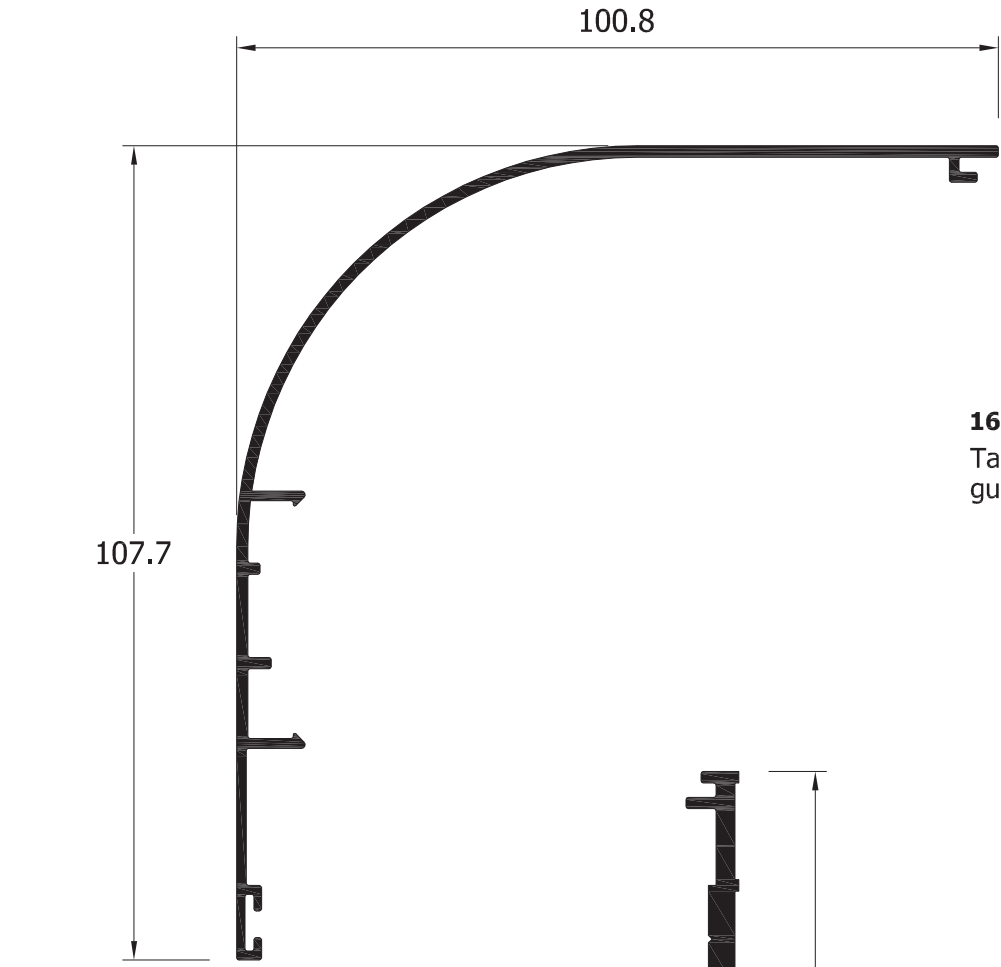

16000
Tapa superior
guia superior frontal

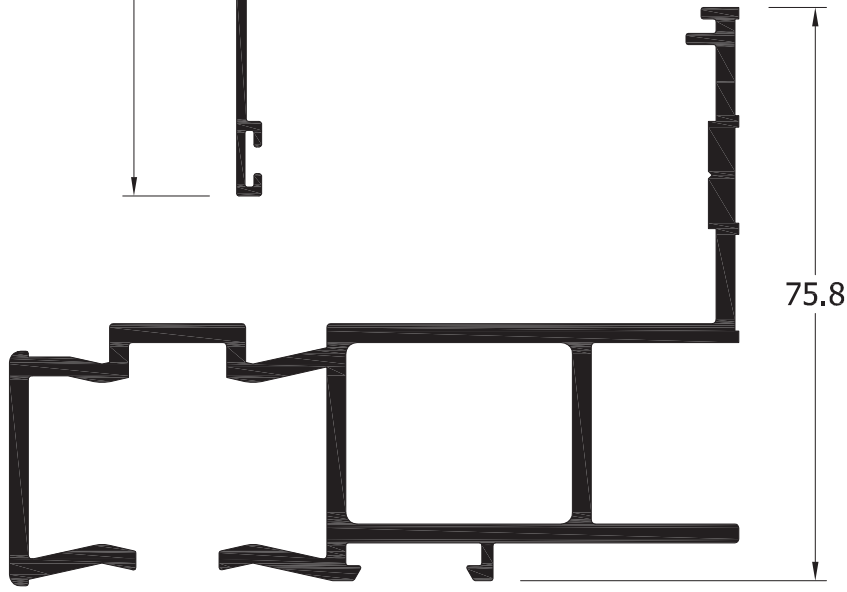

16001
Guia superior frontal

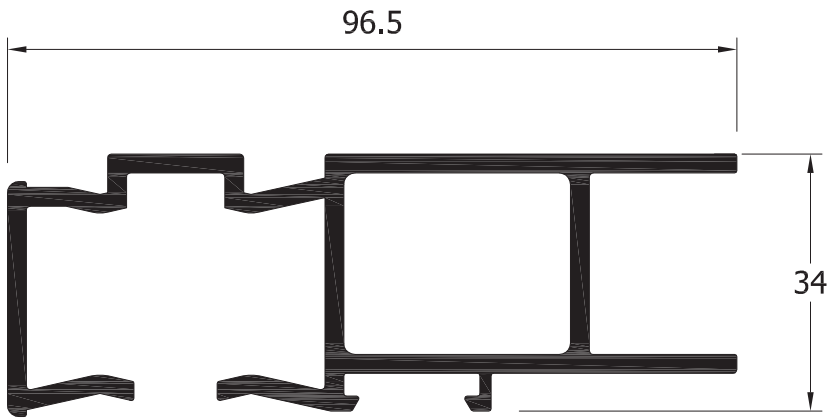

16002
Guia superior forjado

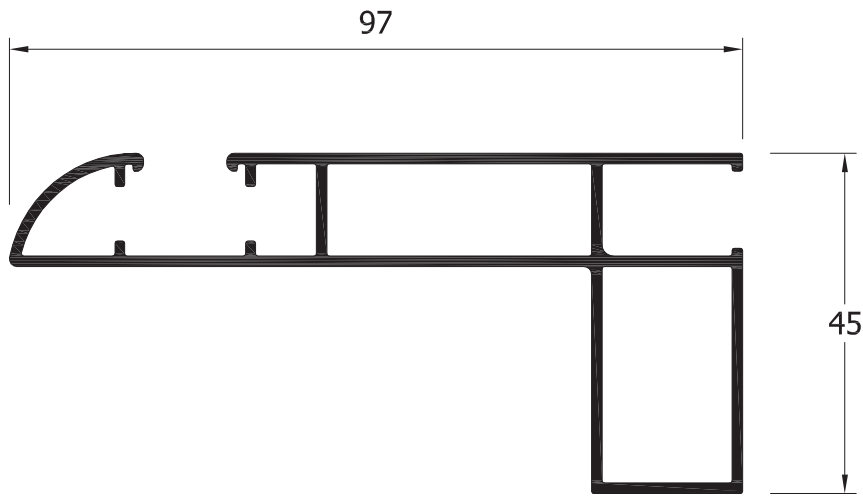

16003
Guia inferior frontal

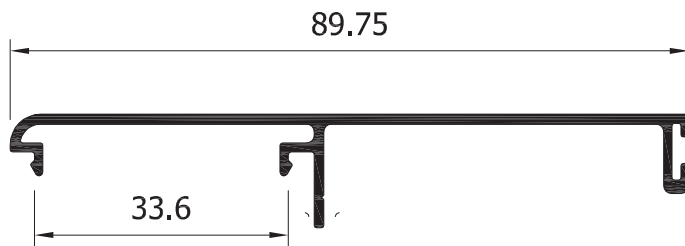

16009
Tapa lateral mallorq.

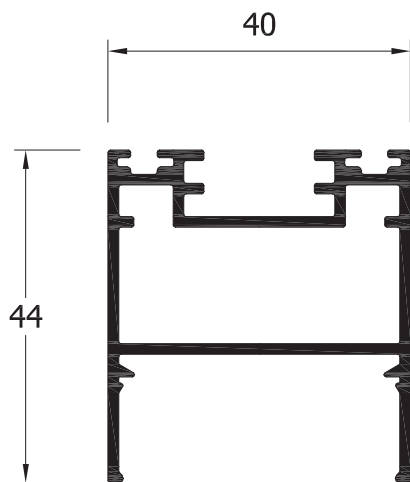

16006
Hoja mallorquina corredera

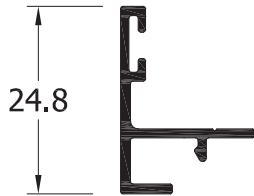

16010
Acople central mallorq.

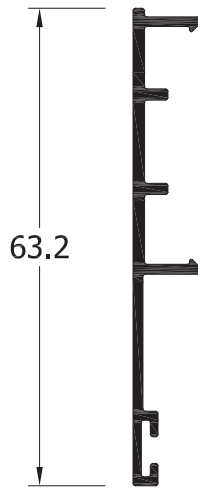

16005
Tapa guia superior forjado

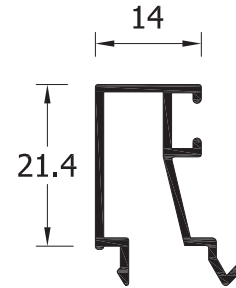

13016
Junquillo 14 mm

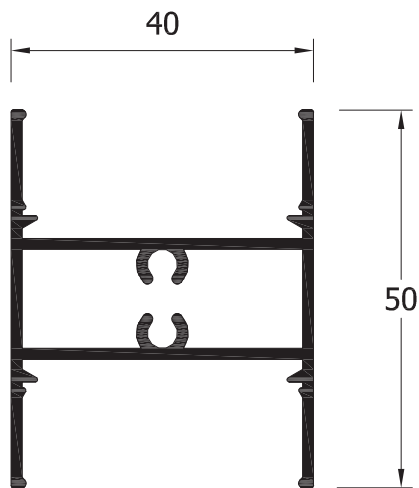

21/16007
Divisor peq. mallorq.

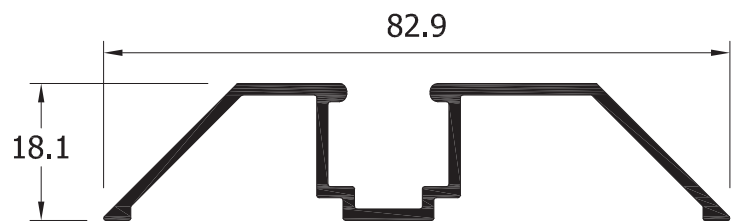

16004
Guia inferior forjado

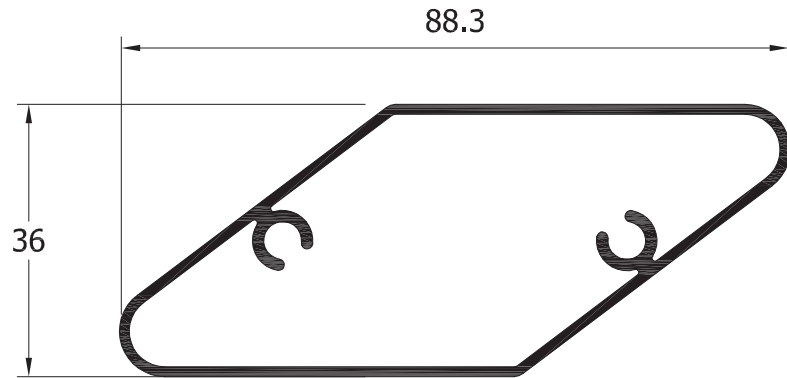

04610
Trav. ovalado mallorq.

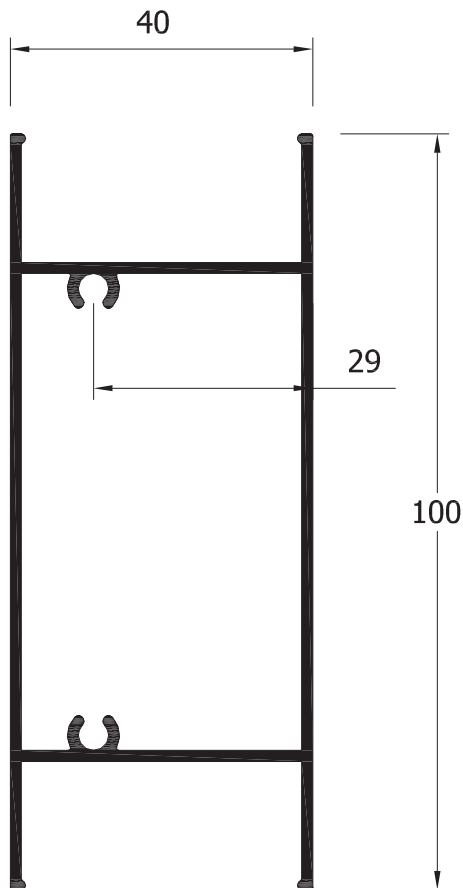

12010
Divisor zócalo
grande mallorq.

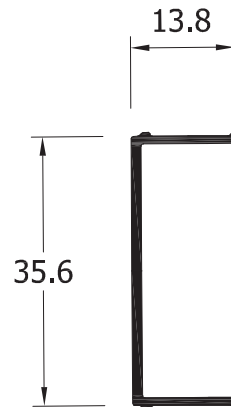

04130
Tapa U mallorquina

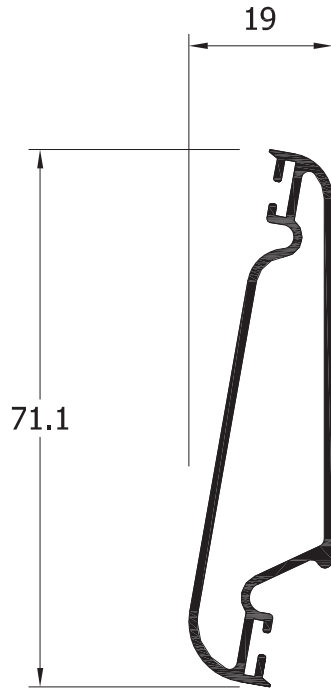

12002
Lama regulable mallorq.

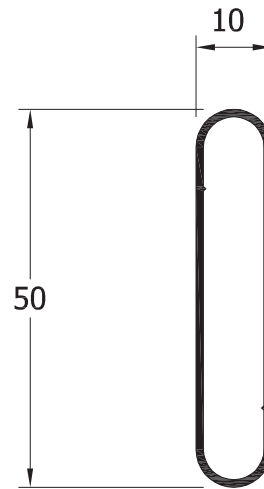

12003
Lama fija mallorq.

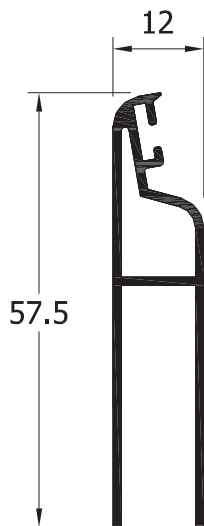

12006
Terminal lama grande mallorq.

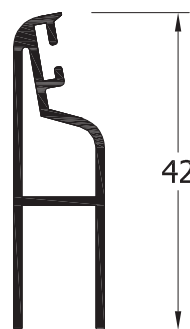

12005
Terminal lama peq. mallorq.

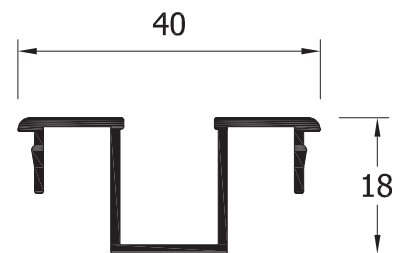

12004
Acople terminal mallorq.

TAPA GUIA SUP.: **16005**
GUIA SUPERIOR: **16002**
HOJA MALLORQ.: **16006**
JUNQUILLO: **13016**
ACOPLE LAMA: **11204**
TERMINAL LAMA: **11205**
LAMA REGULABLE: **11202**

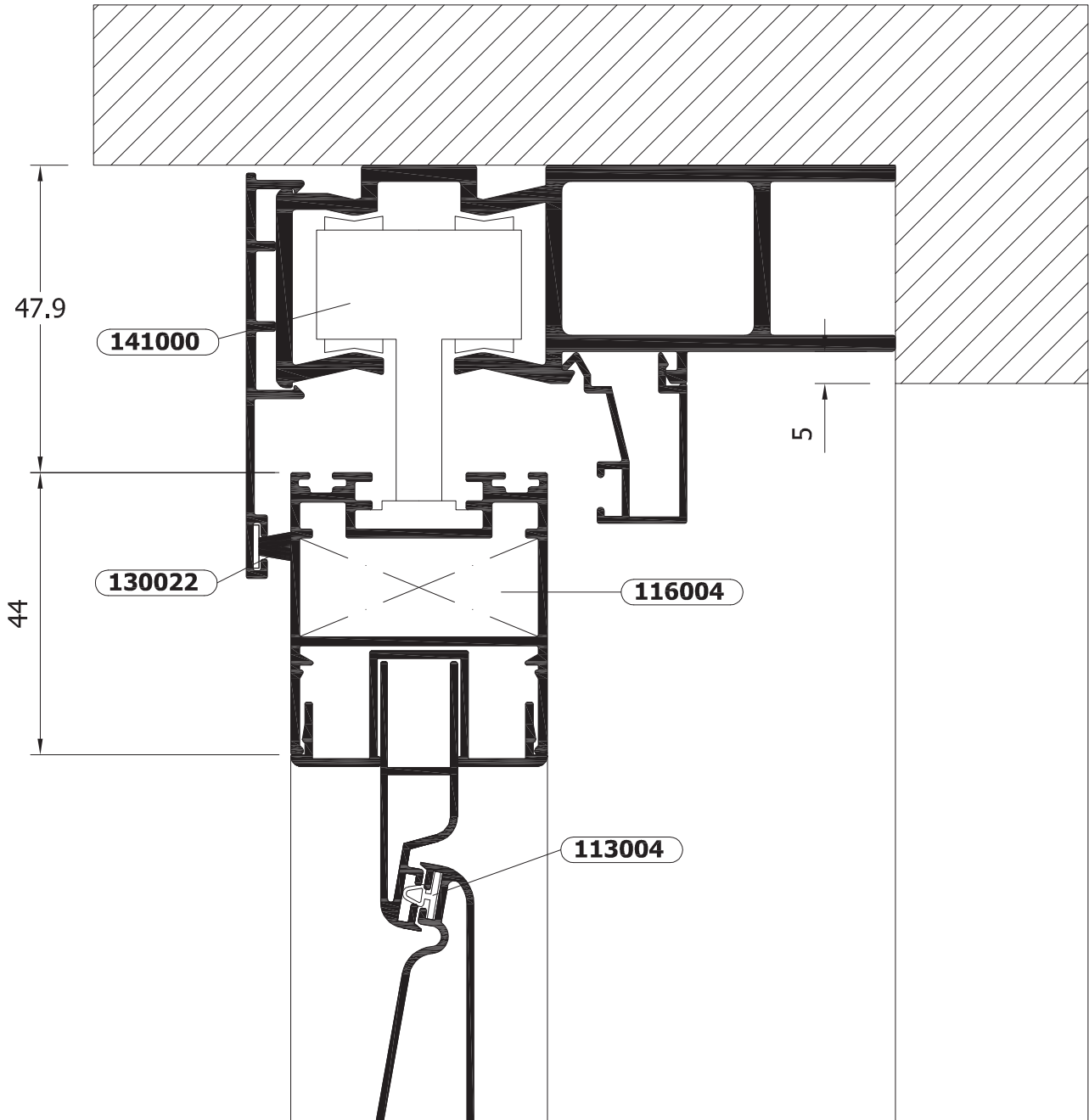
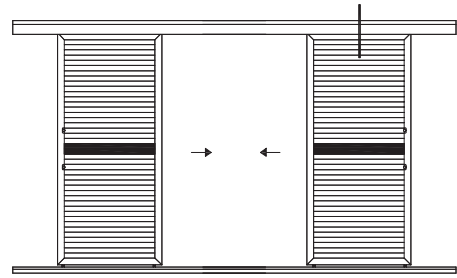

GUIA INFERIOR: **16004**
HOJA MALLORQ.: **16006**
ACOPLE LAMA: **11204**
TERMINAL LAMA: **11205**
LAMA REGULABLE: **11202**

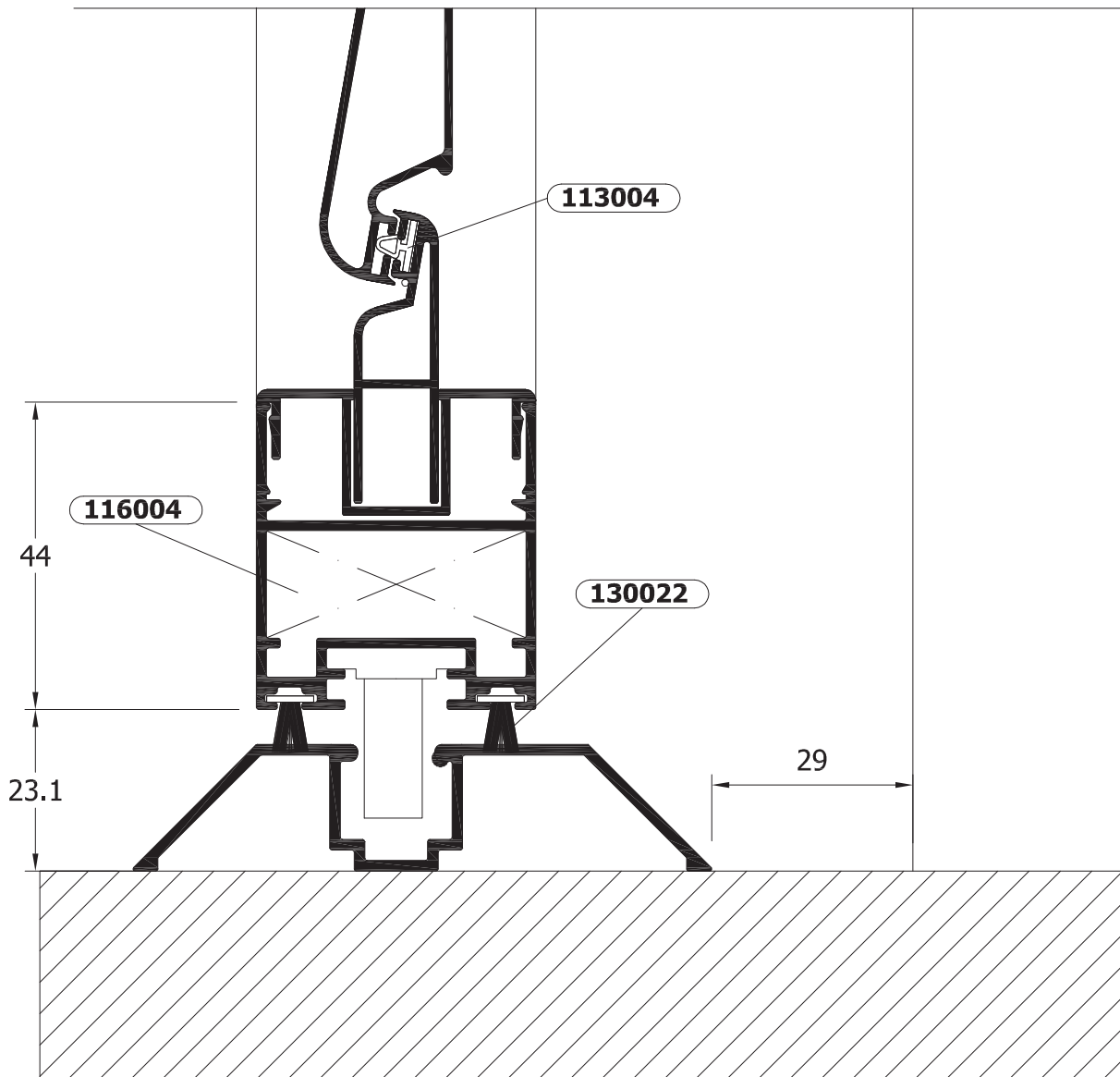
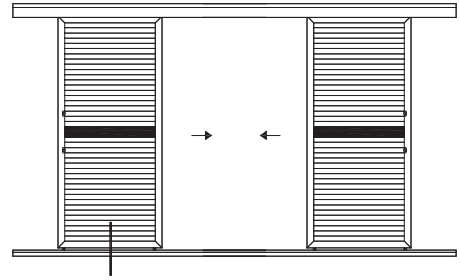

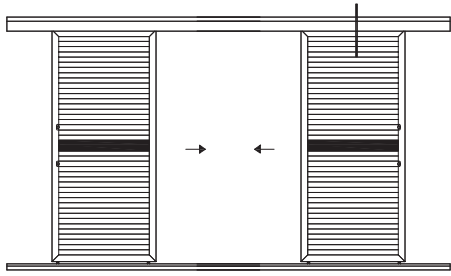

- TAPA GUIA SUP. FAC.: **16000**
- GUIA SUPERIOR FAC.: **16001**
- HOJA MALLORQ.: **16006**
- JUNQUILLO: **13016**
- ACOPLE LAMA: **11204**
- TERMINAL LAMA: **11205**
- LAMA REGULABLE: **11202**

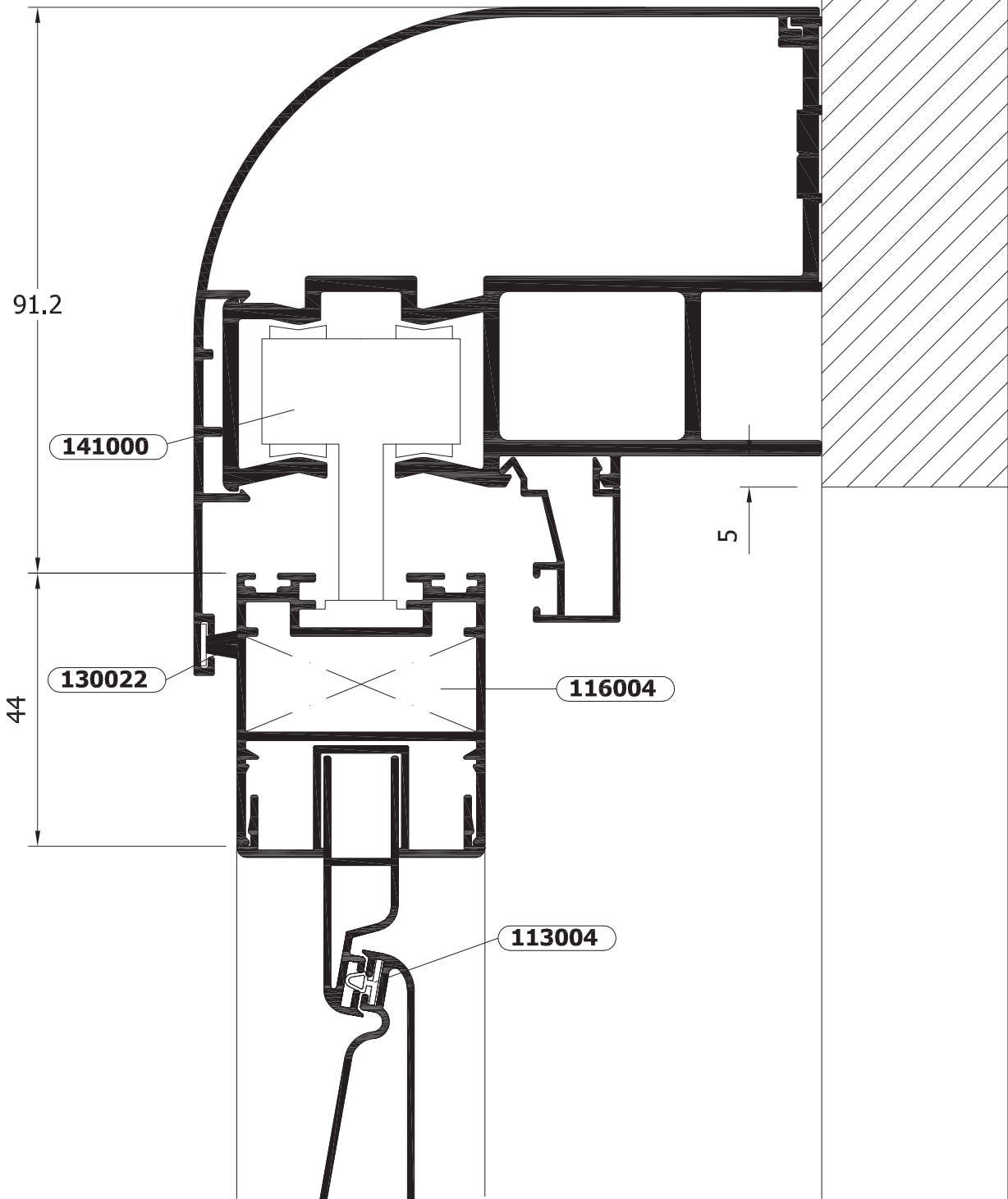

GUIA INTERIOR FAC.: **16003**
HOJA MALLORQ.: **16006**
ACOPLE LAMA: **11204**
TERMINAL LAMA: **11205**
LAMA REGULABLE: **11202**

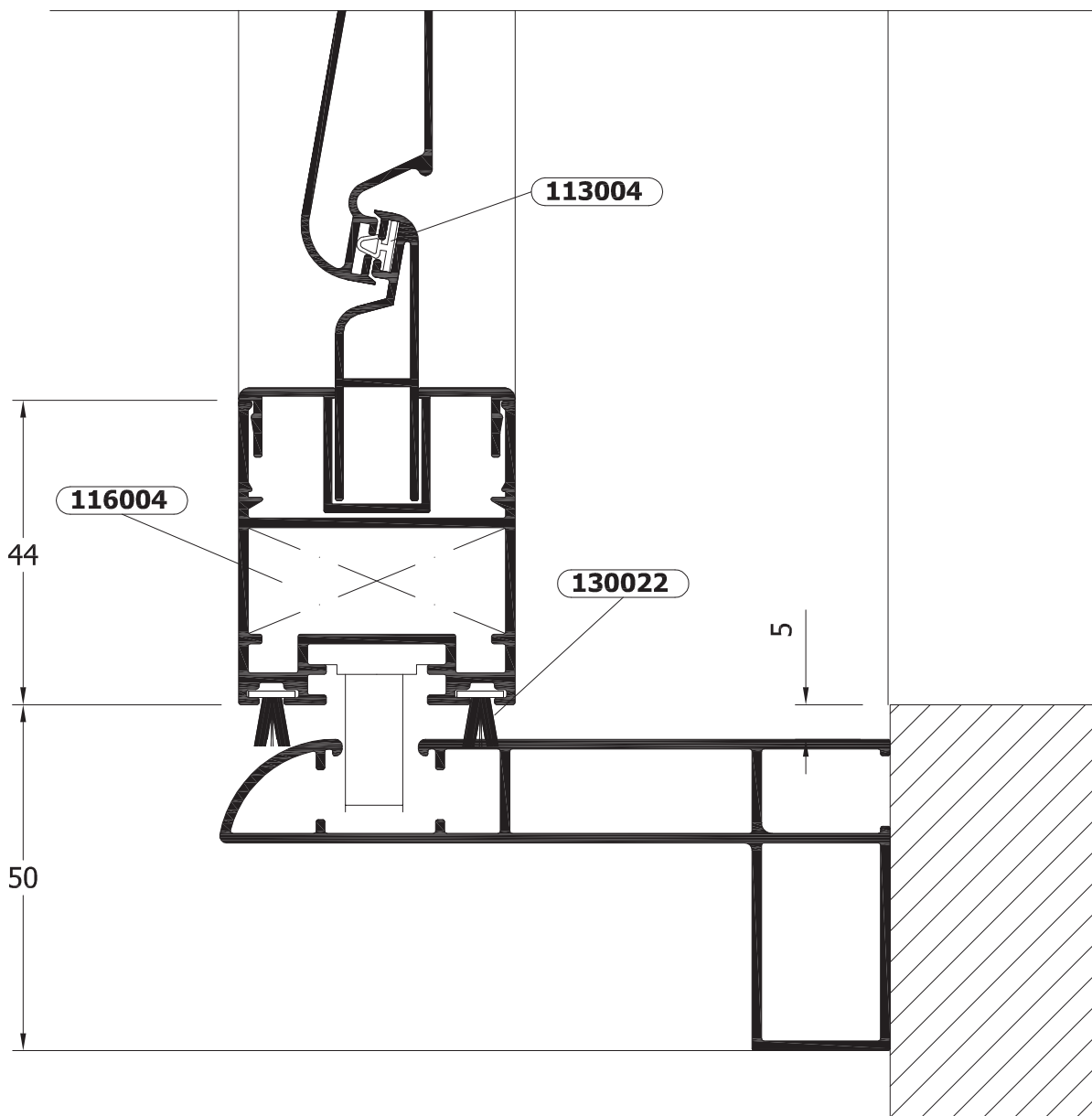
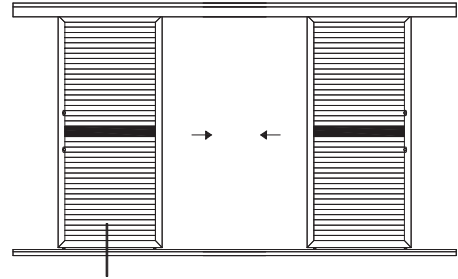

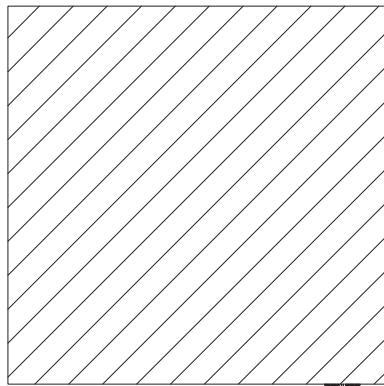

130022

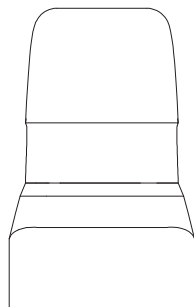

116004

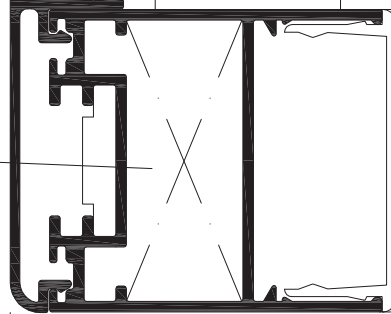

5.2

44

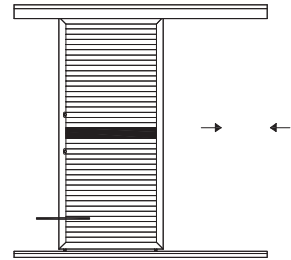

TAPA LATERAL.: **16009**
HOJA MALLORQ.: **16006**

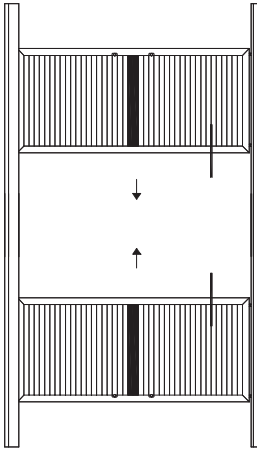

TAPA LATERAL : **16009**
HOJA MALLORQ.: **16006**

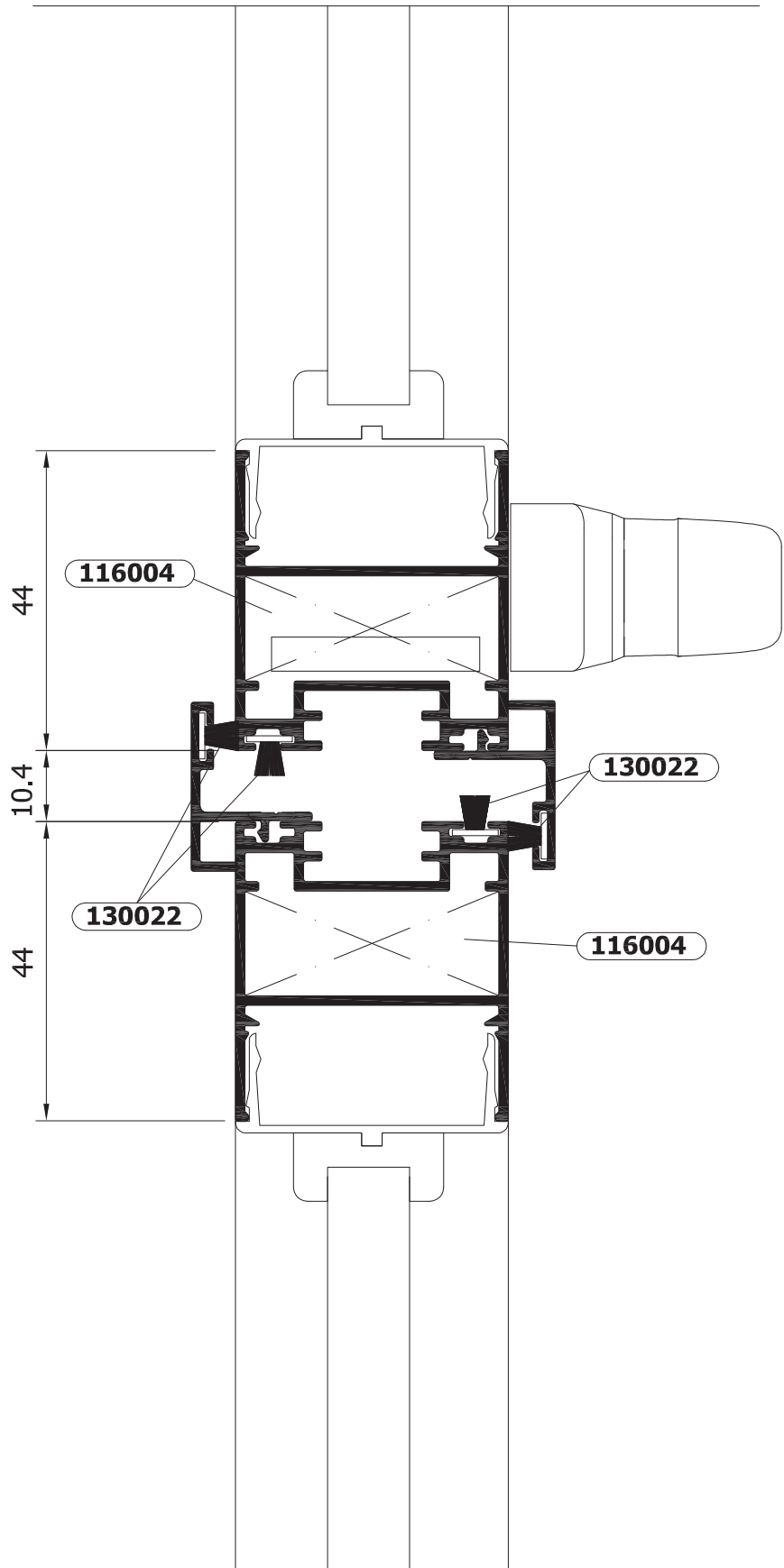

MEDIDAS DE CORTE 2 HOJA FRONTAL FACHADA

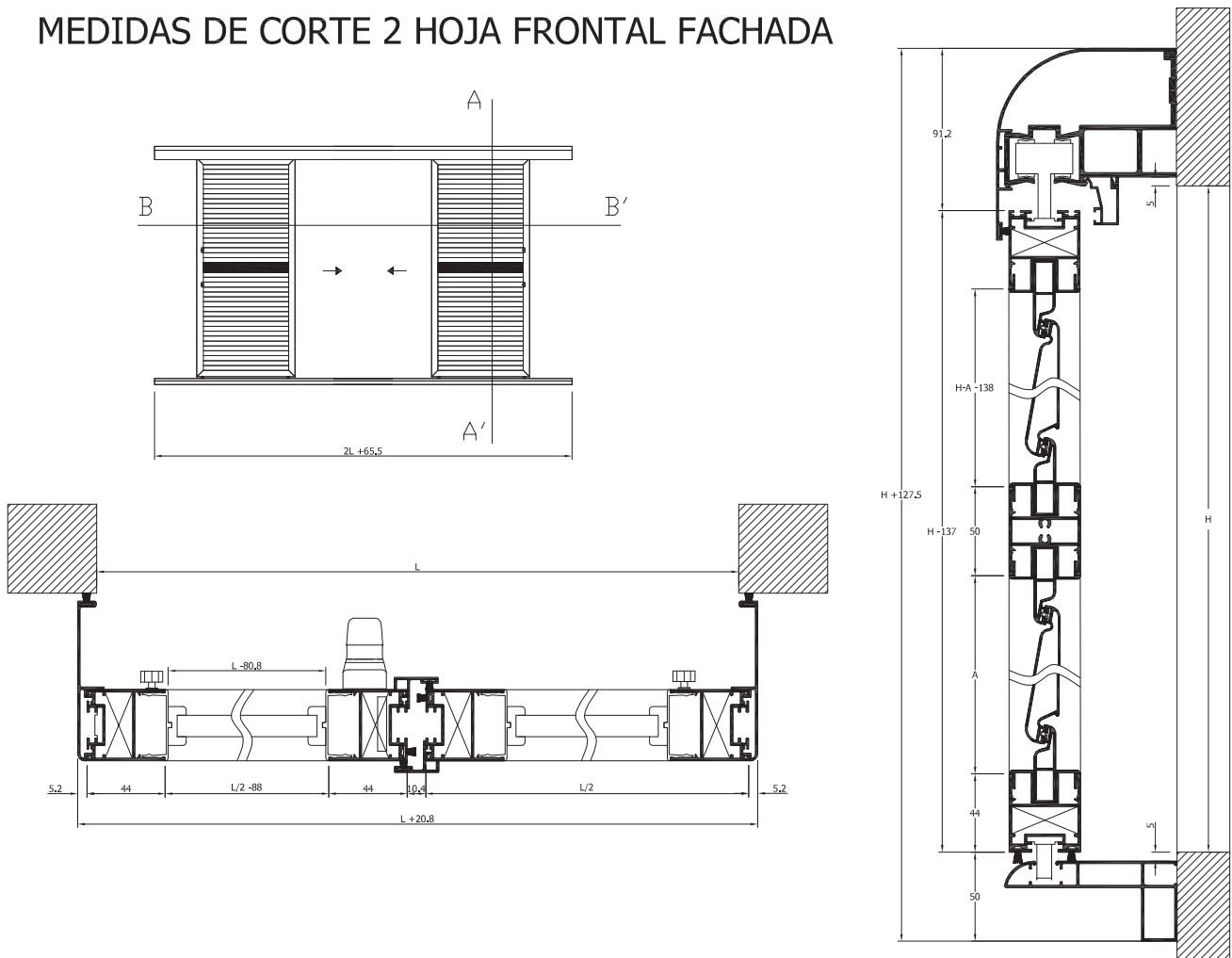

Guía frontal fachada					
Perfil	Ref.	Descripción	Corte	L	H
	16000	Tapa guía sup. fron.		2L +65.5	
	16001	Guía superior front.		2L +65.5	
	16003	Guía inferior front.		2L +65.5	
	16006	Hoja mallorq. corred.		L/2	H-13.7
	16009	Tapa lat. hoja mallor.			H-13.7
	21/16007	Travesaño mallorq.		L/2 -88	
	16010	Acople central ext.			H +4.3
	16010	Acople central int.			H -3.5
	13016	Junquillo 14 mm		2L +65.5	
	12004	Acople lama		L/2 -88	
	12005	Terminal lama		L/2 -80.8	
	12002	Lama regulable		L/2 -80.8	

* Se recomienda la verificación de las medidas antes de su fabricación en serie.

MEDIDAS DE CORTE 2 HOJA ENTRE FORJADOS

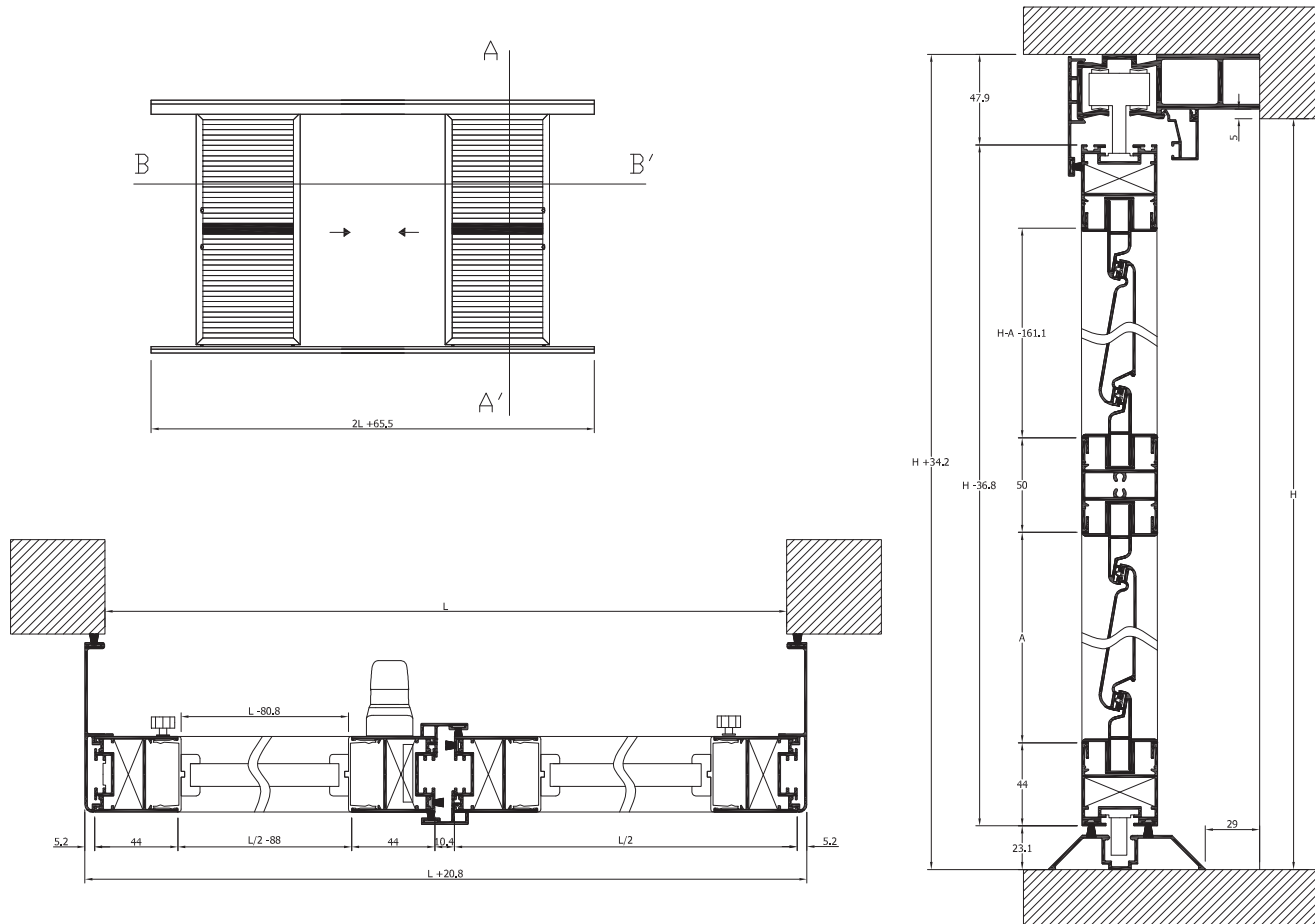

Guia entre forjados					
Perfil	Ref.	Descripción	Corte	L	H
	16005	Tapa guía sup. emp.		2L + 65.5	
	16002	Guia superior emp.		2L + 65.5	
	16004	Guia inferior emp.		2L + 65.5	
	16006	Hoja mallorq. corred.		L/2	H-36.8
	16009	Tapa lat. hoja mallor.			H-36.8
	21/16007	Travesaño mallorq.		L/2 - 88	
	16010	Acople central ext.			H - 18.8
	16010	Acople central int.			H - 27.3
	13016	Junquillo 14 mm		2L + 65.5	
	12004	Acople lama		L/2 - 88	
	12005	Terminal lama		L/2 - 80.8	
	12002	Lama regulable		L/2 - 80.8	

* Se recomienda la verificación de las medidas antes de su fabricación en serie.

MEDIDAS DE CORTE 1 HOJA FRONTAL FACHADA

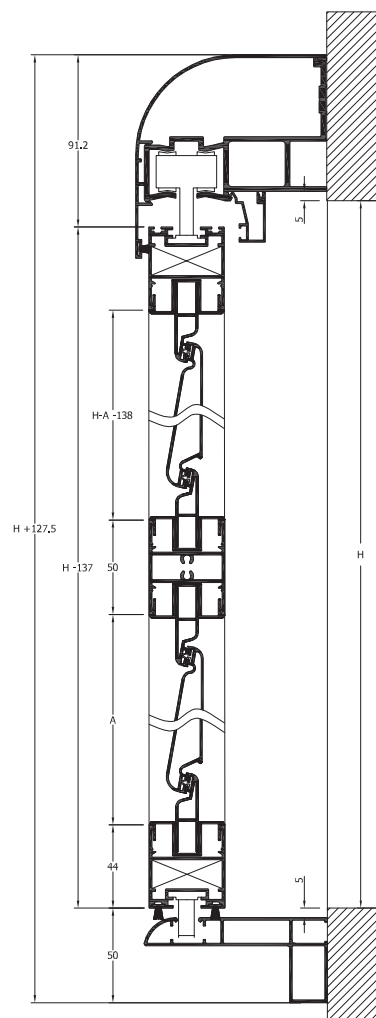
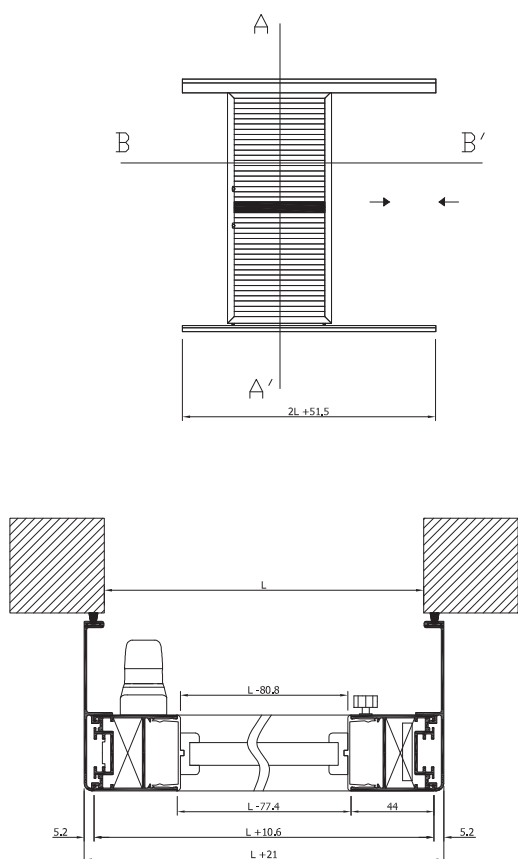







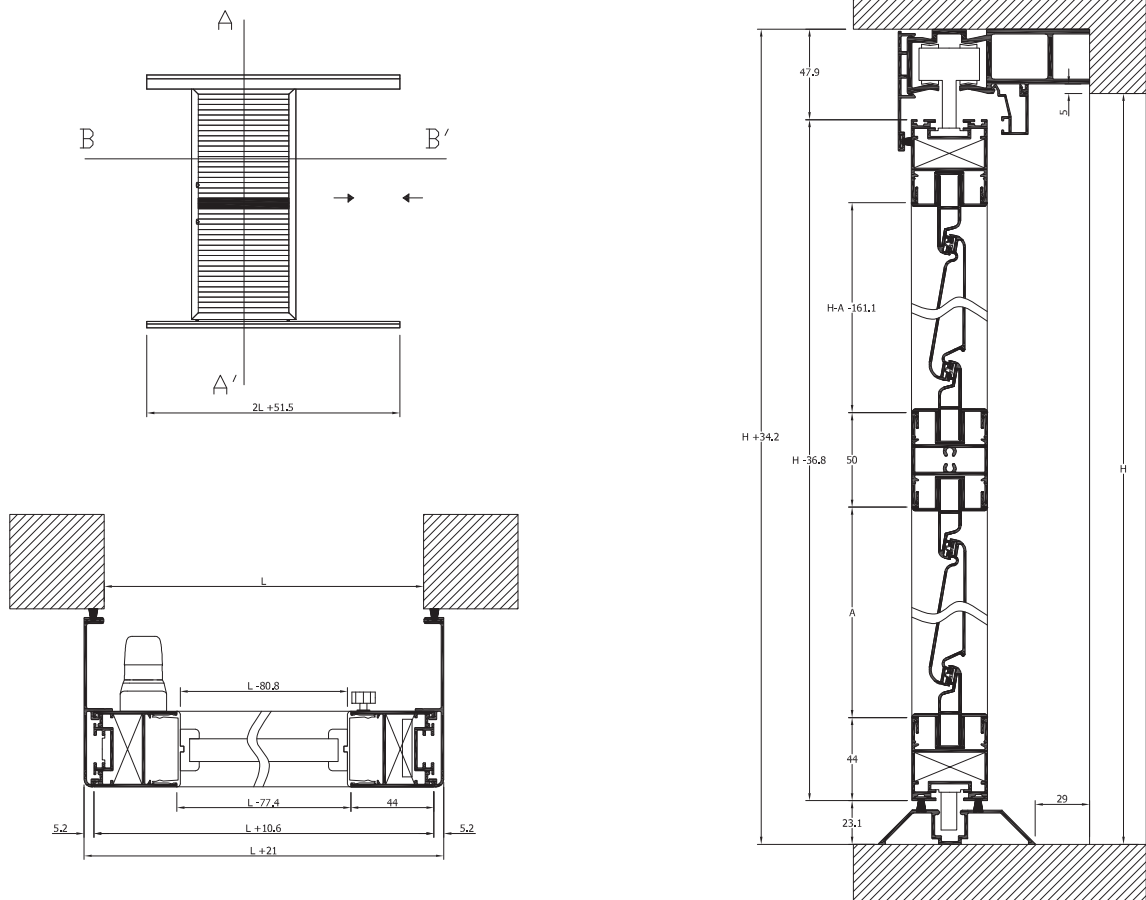





Guia frontal fachada					
Perfil	Ref.	Descripción	Corte	L	H
	16000	Tapa guia sup. fron.		2L + 51.5	
	16001	Guia superior front.		2L + 51.5	
	16003	Guia inferior front.		2L + 51.5	
	16006	Hoja mallorq. corred.		L + 10.6	H - 13.7
	16009	Tapa lat. hoja mallor.			H - 13.7
	21/16007	Travesaño mallorq.		L - 77.4	
	13016	Junquillo 14 mm		2L + 51.5	
	12004	Acople lama		L/2 - 88	
	12005	Terminal lama		L/2 - 80.8	
	12002	Lama regulable		L/2 - 80.8	

* Se recomienda la verificación de las medidas antes de su fabricación en serie.

MEDIDAS DE CORTE 1 HOJA ENTRE FORJADOS













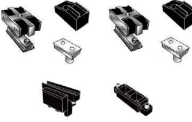

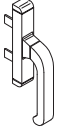
Guia entre forjados

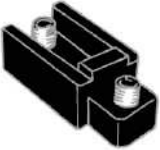
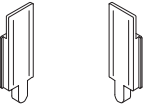

Perfil	Ref.	Descripción	Corte	L	H
	16005	Tapa guia sup. emp.		2L + 51.5	
	16002	Guia superior emp.		2L + 51.5	
	16004	Guia inferior emp.		2L + 51.5	
	16006	Hoja mallorq. corred.		L + 10.6	H - 36.8
	16009	Tapa lat. hoja mallor.			H - 36.8
	21/16007	Travesaño mallorq.		L - 77.4	
	13016	Junquillo 14 mm		2L + 51.5	
	12004	Acople lama		L/2 - 88	
	12005	Terminal lama		L/2 - 80.8	
	12002	Lama regulable		L/2 - 80.8	

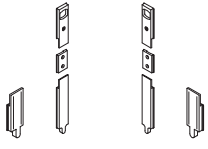
* Se recomienda la verificación de las medidas antes de su fabricación en serie.

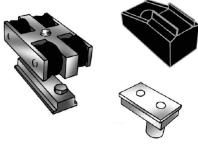
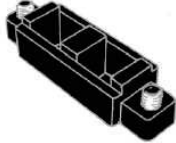
LISTADO ACCESORIO

	Ref.		Ref.
	ACC0 141011 kit 1 hoja mallor. corr.		ACC0 141007 Tapa inf. forjado
	ACC0 141012 kit 2 hoja mallor. corr.		ACC0 141008 Tapa sup. forjado
	ACC0 110034 Cremona Apert. Ext		ACC0 141009 Tapa inf. fachada
	ACC0 110153 Mecan. Apert. Ext.		ACC0 141010 Tapa sup. fachada
	ACC0 110154 Bulón 10 mm		ACC0 141003 Cerradero inf. simple
	ACC0 110151 kit 1 hoja europeo		ACC0 141006 Cerradero sup. doble
	ACC0 110152 kit 2 hoja europeo		ACC0 141004 Cerradero sup. simple
	ACC0 141000 Conjunto rodam. sup.		ACC0 141005 Cerradero inf. doble

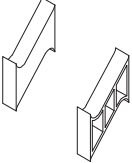
LISTADO ACCESORIO

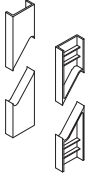
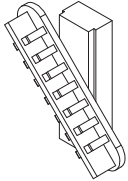
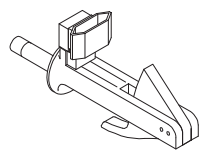
	Ref.		Ref.
	ACC0 116004 Esc. hoja mallorq. corr.		ACC0 130022 (Rollo de 275 m.)
	ACC0 113051 Separador lama der.		ACC0 113004 Goma lama regulable (Rollo de 200 mts)
	ACC0 113052 Separador lama izq.		ACC0 113019 Mando mecan. mallorq.
	ACC0 113053 Terminal lama der.		ACC0 113041 Manilla porta-lama derec.
	ACC0 113054 Terminal lama izq.		ACC0 113042 Manilla porta-lama izq.
	ACC0 113047 Soporte lama der.		ACC0 11305 Grillo sujec. simple hoja
	ACC0 113048 Soporte lama izq.		ACC0 11306 Grillo sujec. doble hoja

MECANISMO MALLORQUINA

MECANISMO PORTA-LAMA

Referencia	Nº de lamas	Altura mín. de corte (mm)	Altura estándar (mm)	Altura ventana (mm)	
				Mínimo	Máximo
113022	6	400	460	590	650
113023	7	460	520	650	710
113024	8	520	580	710	770
113025	9	580	640	770	830
113026	10	640	700	830	890
113027	11	700	760	890	950
113028	12	760	820	950	1010
113029	13	820	880	1010	1070
113030	14	880	940	1070	1130
113031	15	940	1000	1130	1190
113032	16	1000	1060	1190	1250
113033	17	1060	1120	1250	1310
113034	18	1120	1180	1310	1370
113035	19	1180	1240	1370	1430
113036	20	1240	1300	1430	1490
113037	21	1300	1360	1490	1550
113038	22	1360	1420	1550	1610
113039	23	1420	1480	1610	1670
113040	24	1480	1540	1670	1730
-	25	1540	1600	1730	1790
-	26	1600	1660	1790	1850
-	27	1660	1720	1850	1910
-	28	1720	1780	1910	1970
-	29	1780	1840	1970	2030
-	30	1840	1900	2030	2090

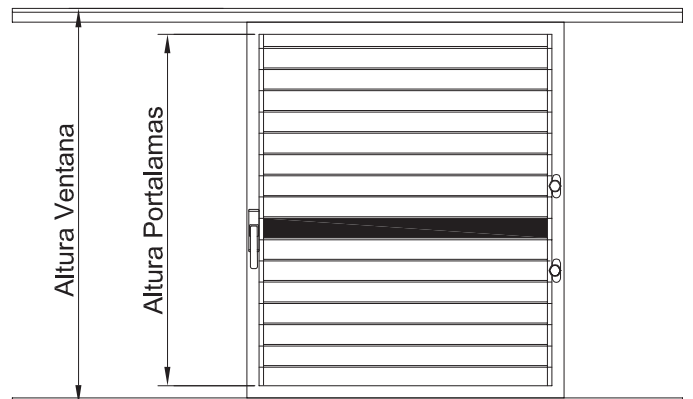
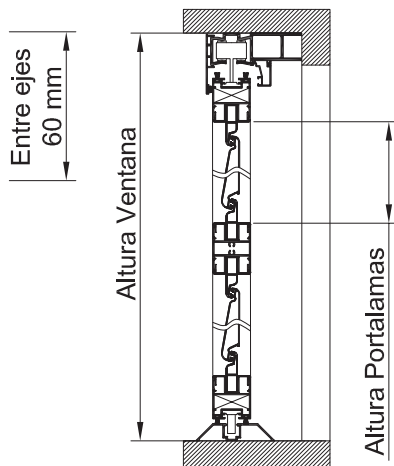
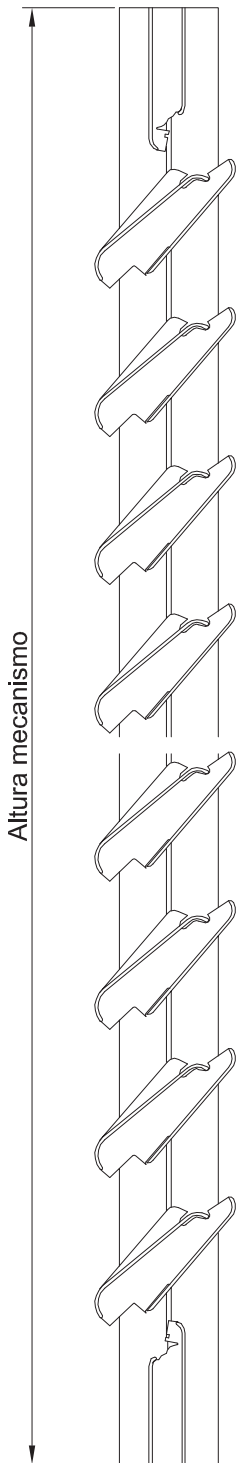



www.aluminiosfranco.es
Murcia 968 271 050
Valencia 961 212 816
Tarragona 977 525 572

alf **aluminios
franco**

