

 **aluminios franco, s.a.**

MALLORQUINA ABISAGRADA



CARACTERISTICAS MALLORQUINA ABISAGRADA

- Sistema de carpintería para ventanas y puertas abatibles de marco de 40 mm y hoja de 40 mm .
- Posibilidad de lama fija y lama regulable.
- Apertura interior y exterior.
- Montaje de marco y hojas, corte a inglete con escuadras.
- Sistema que permite un alto grado de protección solar y óptima visibilidad exterior.
- Permite una apertura de grandes dimensiones, dejando acceder al hueco total de la ventana o puerta.
- Características que cumplen las exigencias del mercado.
- Aleación 6063 T-5.

APERTURAS

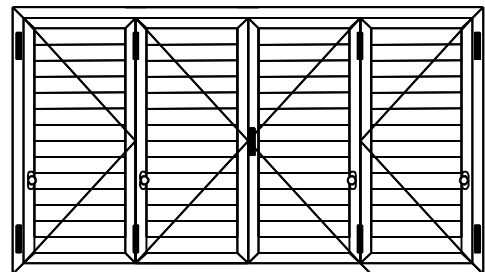
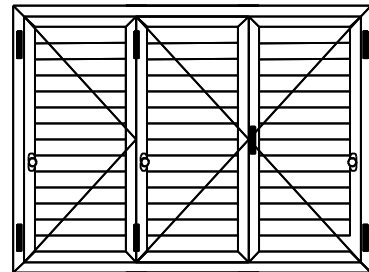
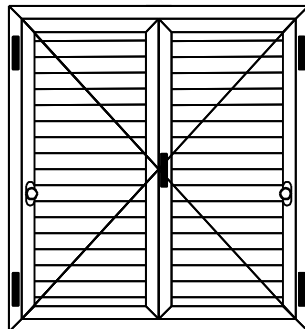
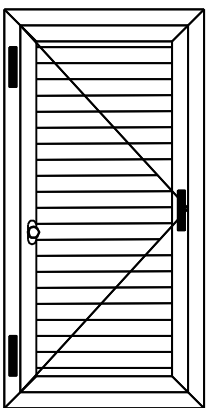

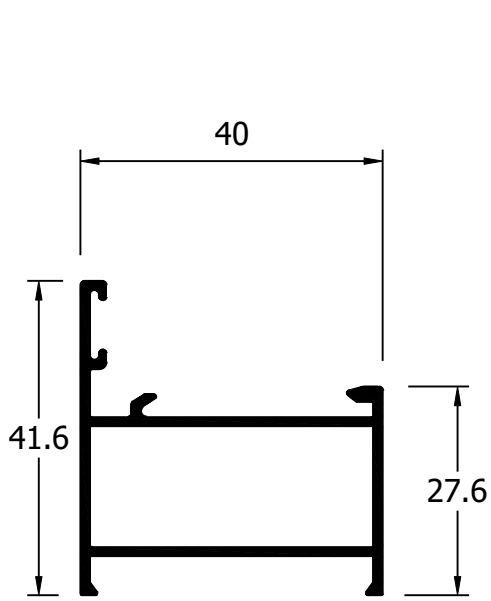

11001
Marco ventana

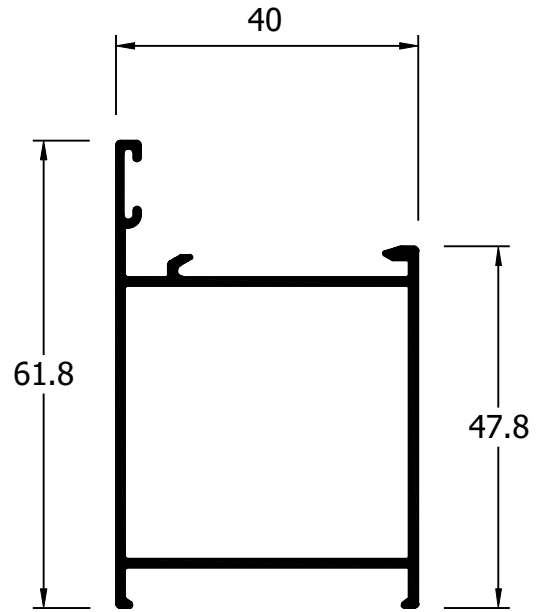

11004
Marco puerta

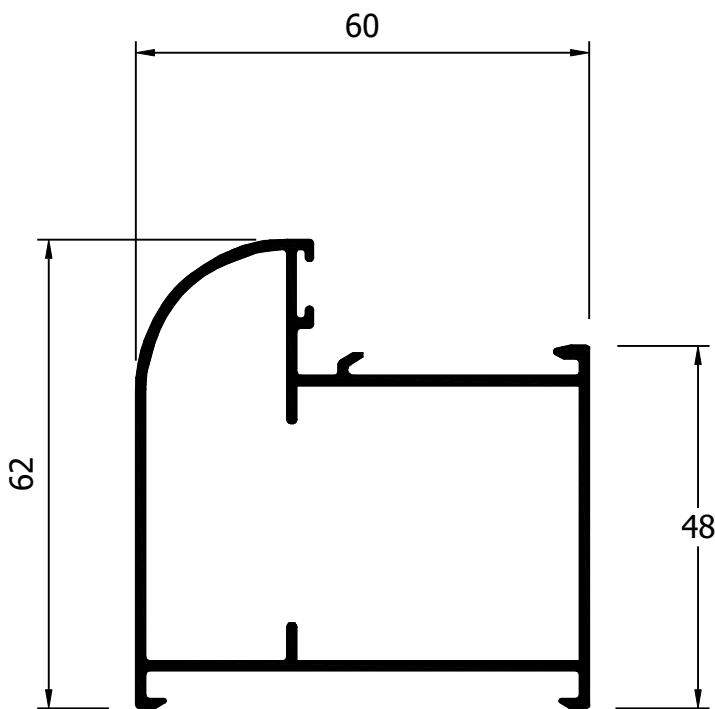

11017
Marco Curvo

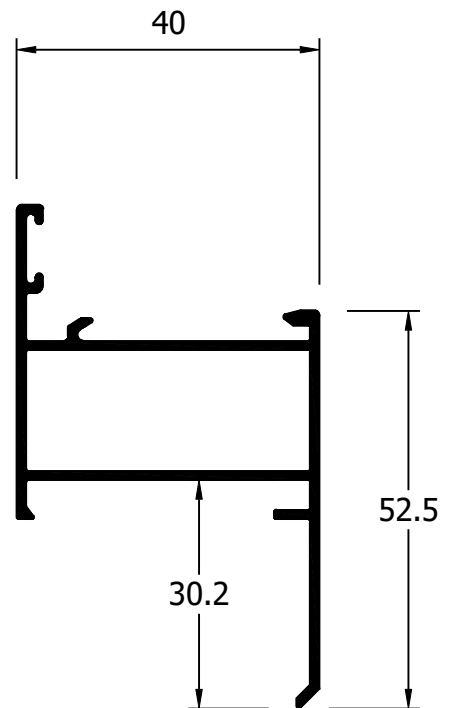

11021
Marco solape

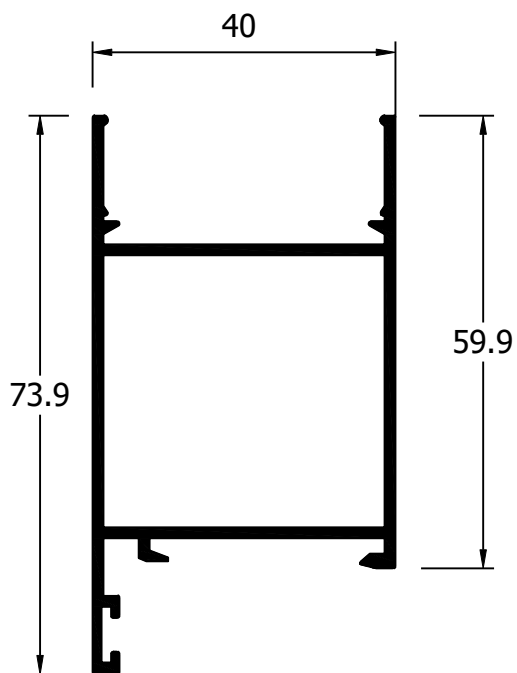

12011
Hoja puerta mallorq.

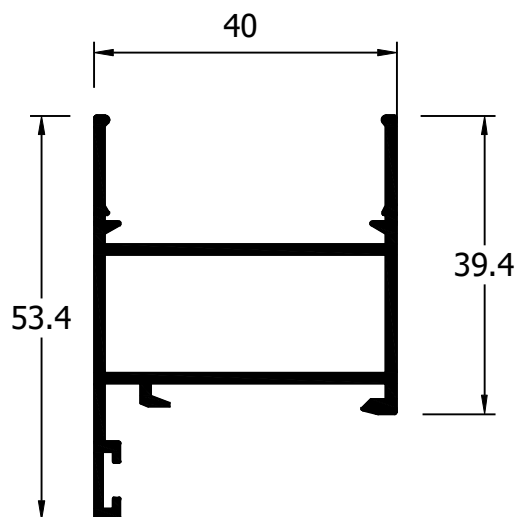

12000
Hoja ventana mallorq.

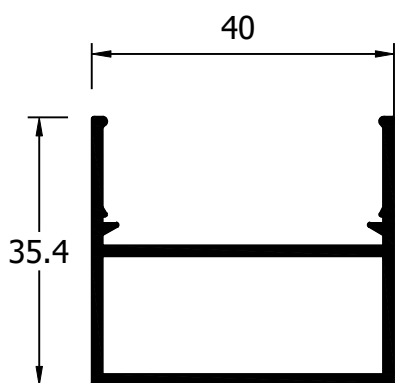

12009
Marco cerrado mallorq.

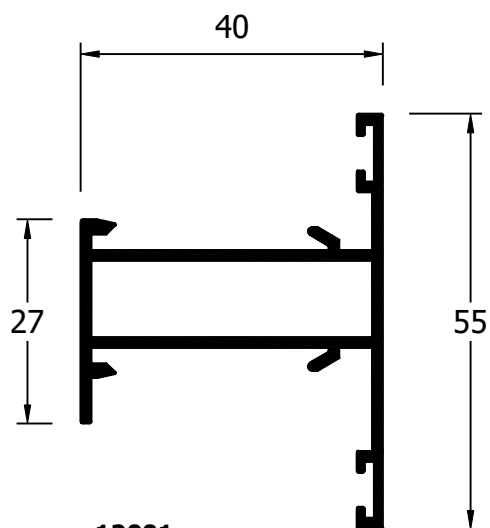

12001
Inversor mallorq.

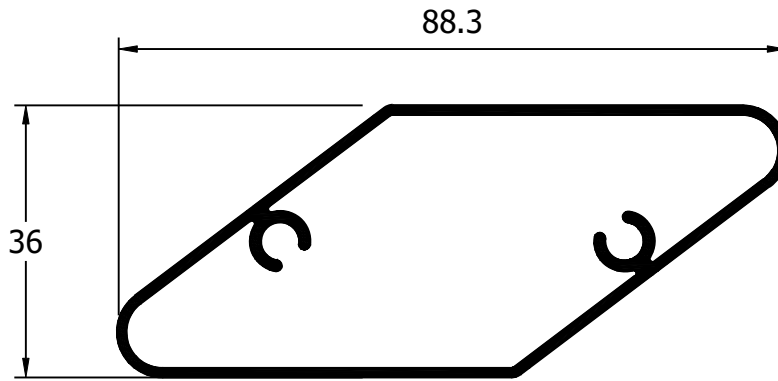

04 10
Trav. ovalado mallorq.

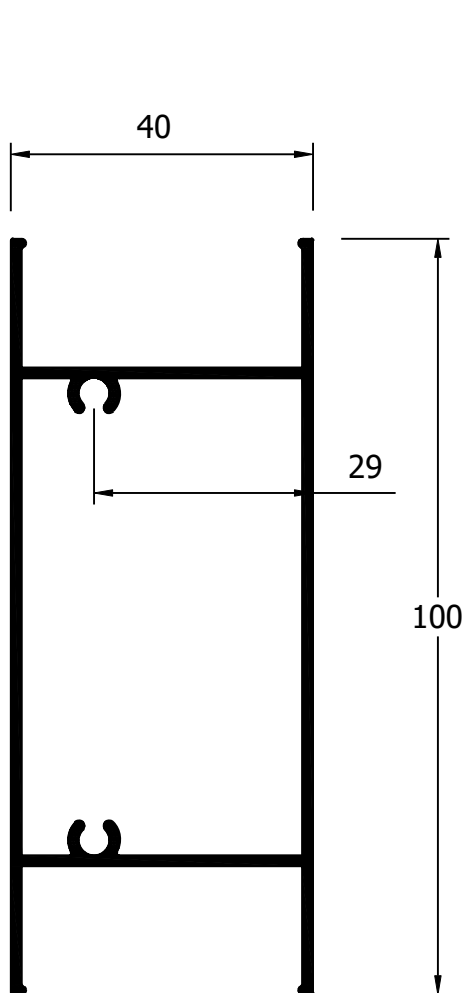

12010
Divisor zócalo grande mallorq.

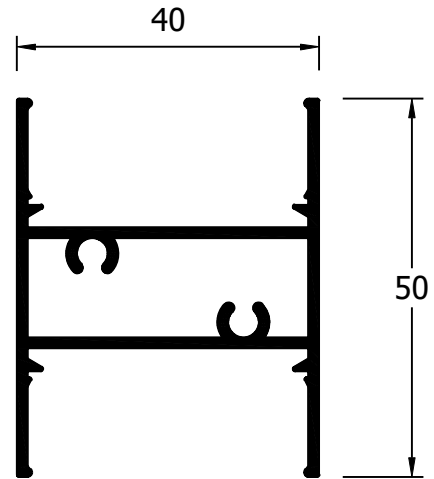

12007
Divisor peq. mallorq.

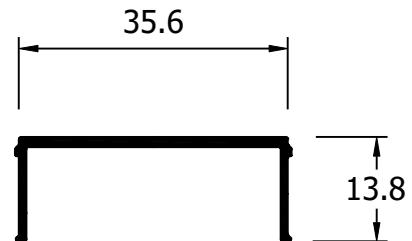

041 0
Tapa U mallorquina

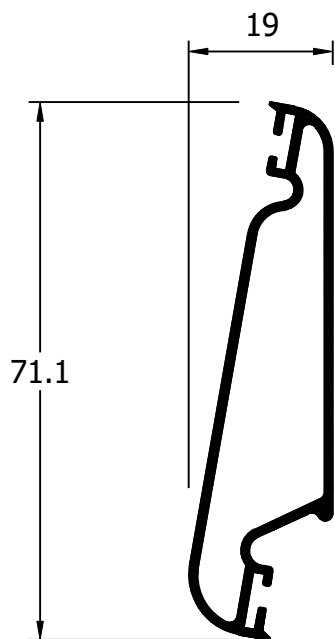

12002
Lama regulable mallorq.

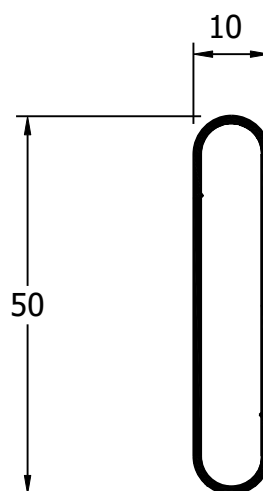

1200
Lama fija mallorq.

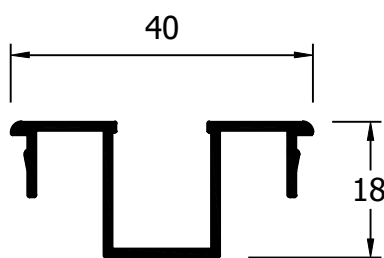

12004
Acople terminal mallorq.

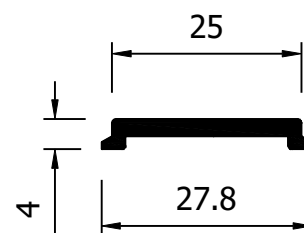

11009
Pletina falleba 40x20

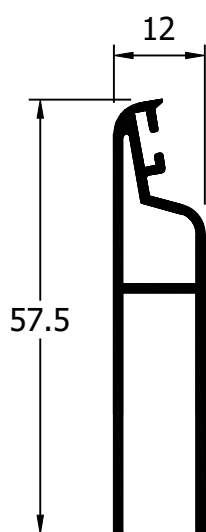

1200
Terminal lama grande mallorq.

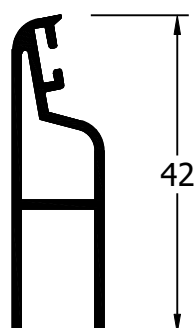



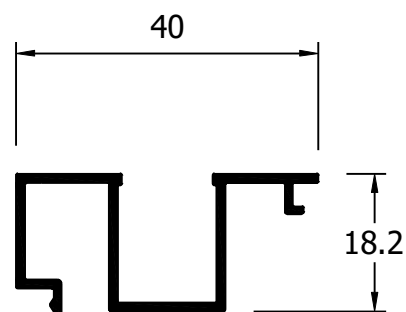



1200
Terminal lama peq. mallorq.







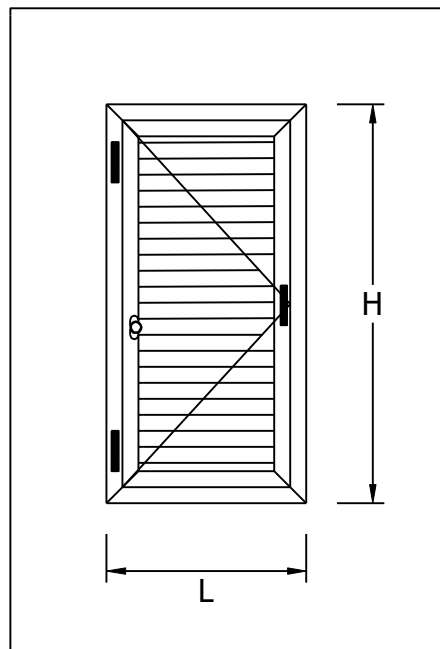

12012
Acople marco mallorq.

MEDIDAS DE CORTE 1 HO A









Marco hoja ventana					
Perfil	Ref.	Descripción	Corte	L	H
	11001	Marco ventana		L	H
	12000	hojas vent. mall.		L-43.2	H-43.2
	12004	Acople lama h.lat.		L-153.6	
	12005	Terminal h.lat.		L-150.2	
	12002	Lama regul. h.lat.		L-150.2	









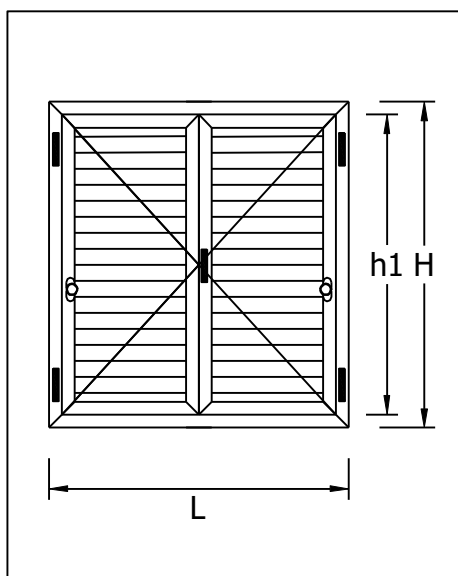

Marco hoja puerta					
Perfil	Ref.	Descripción	Corte	L	H
	11004	Marco puerta		L	H
	12011	Hoja puert. mall.		L-83.6	H-83.6
	12004	Acople lama h.lat.		L-231.4	
	12005	Terminal h.lat.		L-234.8	
	12002	Lama regul. h.lat.		L-234.8	

* Se recomienda la verificación de las medidas antes de su fabricación en serie.

MEDIDAS DE CORTE 2 HO AS

Marco hoja ventana					
Perfil	Ref.	Descripción		L	H
	11001	Marco ventana		L	H
	12000	hojas vent. mall.		L 2-29.1	H-43.2
	12001	Inversor mallorq.			h1-28.2
	12004	Acople lama h.lat.		L 2-136.1	
	12005	Terminal h.lat.		L 2-139.5	
	12002	Lama regul. h.lat.		L 2-139.5	



Marco hoja puerta					
Perfil	Ref.	Descripción		L	H
	11004	Marco puerta		L	H
	12011	Hoja puert. mall.		L 2-49.3	H-43.2
	12001	Inversor mallorq.			h1-28.2
	12004	Acople lama h.lat.		L 2-197.1	
	12005	Terminal h.lat.		L 2-200.5	
	12002	Lama regul. h.lat.		L 2-200.5	

* Se recomienda la verificación de las medidas antes de su fabricación en serie.

MEDIDAS DE CORTE 3 HOJAS

Medidas de corte 3 hojas (mm)



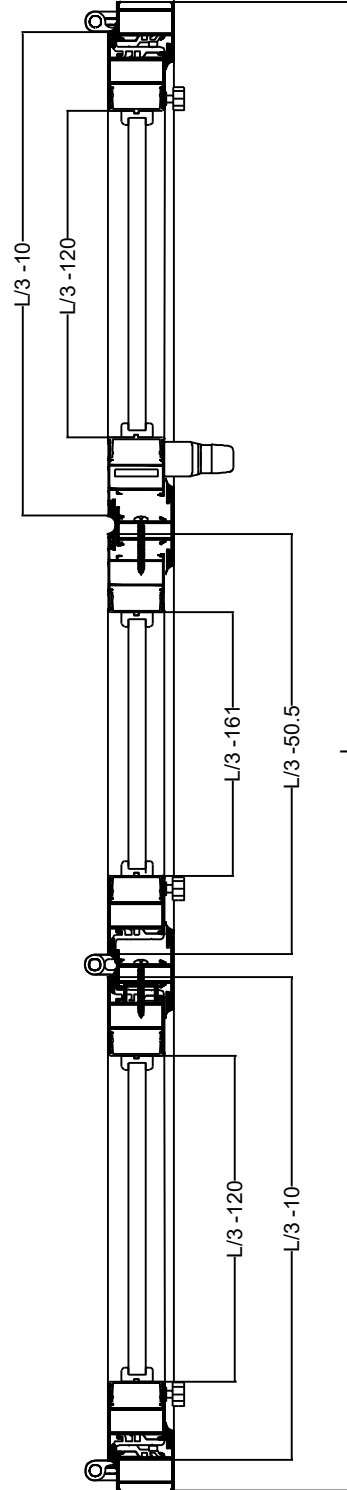
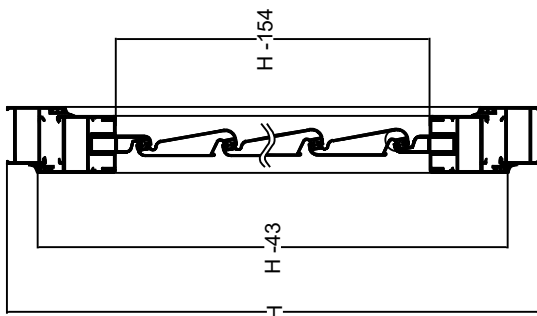
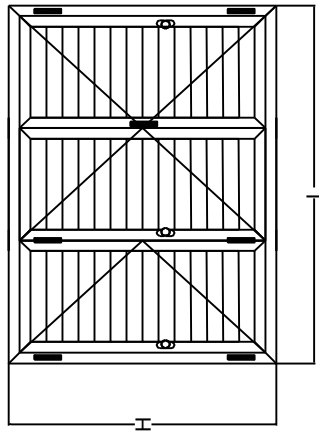









Perfil	Ref.	Descripción	Corte	L	H
	11001	Marco ventana		L	H
	12000	hojas laterales		L / 3 - 10	H - 43
	12000	Hoja central		L / 3 - 50.5	H - 43
	12001	Inversor mallorq.			H - 71
	12004	Acople lama h.lat.		L / 3 - 117	
	12005	Terminal h.lat.		L / 3 - 120	
	12002	Lama regul. h.lat.		L / 3 - 120	
	12004	Acople lama h.cent.		L / 3 - 157.5	
	12005	Terminal h.cent.		L / 3 - 161	
	12002	Lama regul. h.cent.		L / 3 - 161	



* Se recomienda la verificación de las medidas antes de su fabricación en serie.

MEDIDAS DE CORTE 4 HOJAS

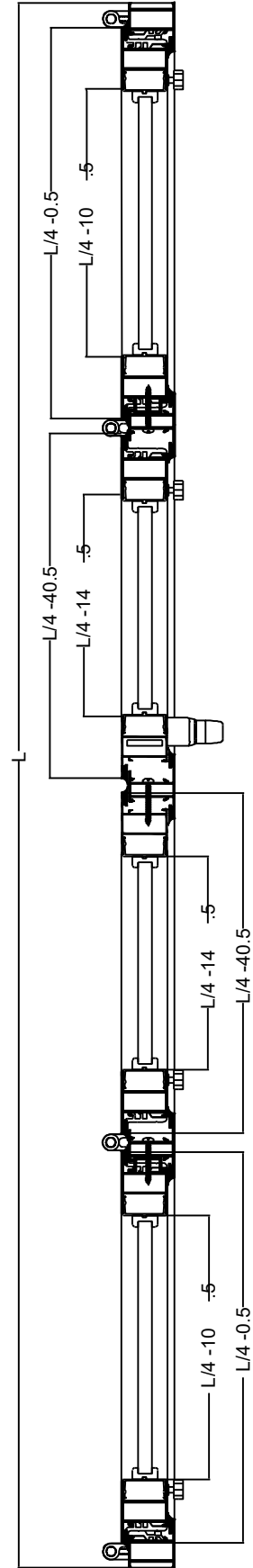
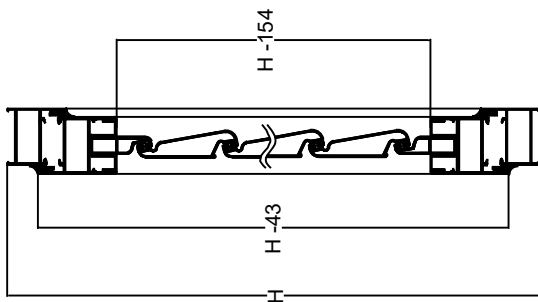
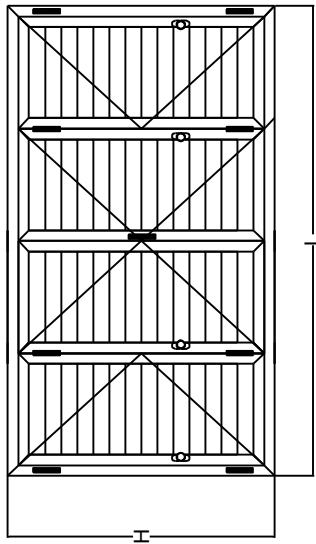

Medidas de corte 4 hojas (mm)

Perfil	Ref.	Descripción	Corte	L	H
	11001	Marco ventana		L	H
	12000	hojas laterales		L /4 -3.5	H -43
	12000	Hojas centrales		L /4 -42.1	H -43
	12001	Inversor mallorq.			H -71
	12004	Acople lama h.lat.		L/3 -110.4	
	12005	Terminal h.lat.		L/4 -113.8	
	12002	Lama regul. h.lat.		L/4 -113.8	
	12004	Acople lama h.cen.		L/3 -149	
	12005	Terminal h.cen.		L/4 -152.5	
	12002	Lama regul. h.cen.		L/4 -152.5	





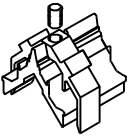
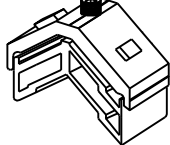
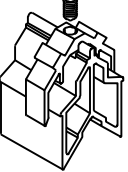
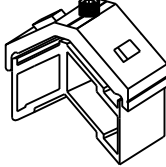
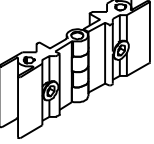
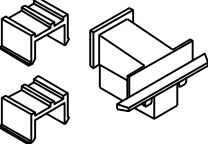
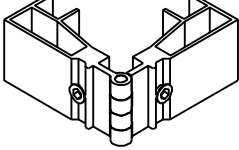
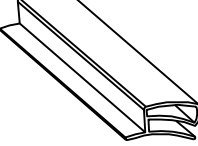
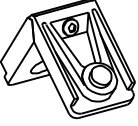
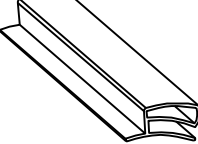
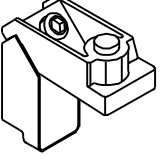

* Se recomienda la verificación de las medidas antes de su fabricación en serie.



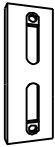
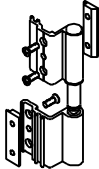

LISTADO ACCESORIO

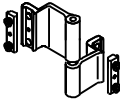
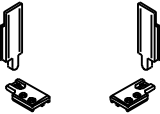
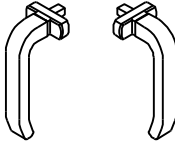
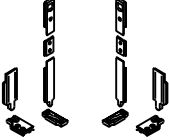
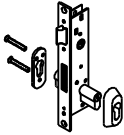
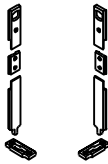
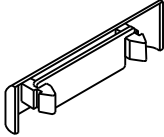
	Ref.		Ref.
	ACC0 112011 Esc. desplazada puerta		ACC0 112009 Esc. cerrada ventana (marco/hoja)
	ACC0 112012 Esc. desplazada ventana		ACC0 112010 Esc. cerrada puerta (marco/hoja)
	ACC0 112013 Esc. ventana regulable		ACC0 113085 J. tapón inversor mall.
	ACC0 112207 Esc. puerta regulable		ACC0 113003 Goma hoja (Rollo de 200 mts)
	ACC0 116004 Esc. marco/hoja ventana		ACC0 112002 Goma marco (Rollo de 300 mts)
	ACC0 116005 Esc. marco/hoja puerta		ACC0 113004 Goma lama regulable (Rollo de 200 mts)

LISTADO ACCESORIO

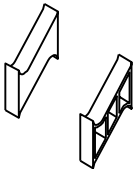
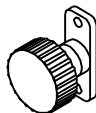
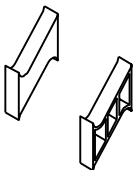
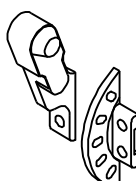
	<p>Ref.</p> <p>ACC0 110153</p> <p>Mecan. Apert. Ext.</p>		<p>Ref.</p> <p>ACC0 112048</p> <p>Bisagras 40x20</p>
	<p>ACC0 110154</p> <p>Bulón 10 mm</p>		<p>ACC0 113007</p> <p>Bisagra 3ª hoja</p>
	<p>ACC0 110034</p> <p>Cremona Apert. Ext</p>		<p>ACC0 113010</p> <p>Bisagra 4ª hoja</p>
	<p>ACC0 113000</p> <p>it 1 hoja mallorq.</p>		<p>ACC0 112026</p> <p>Maneta doble cuadrad.</p>
	<p>ACC0 113001</p> <p>it 2 hojas mallorq.</p>		<p>ACC0 110251</p> <p>Cerradura 25 mm</p>
	<p>ACC0 113002</p> <p>it h. pasiva mallorq.</p>		<p>ACC0 110155</p> <p>Tapa salida de agua</p>

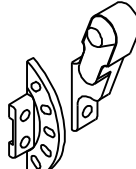
LISTADO ACCESORIO

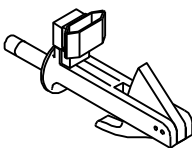
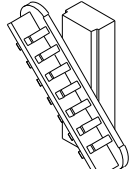
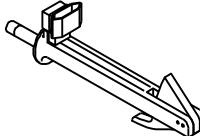
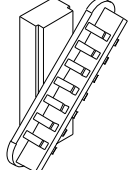
	Ref.		Ref.
	ACC0 113051 Separador lama der.		ACC0 113019 Mando mecan. mallorq.
	ACC0 113052 Separador lama i q.		ACC0 113041 Manilla porta-lama derec.
	ACC0 113053 Terminal lama der.		ACC0 113042 Manilla porta-lama i q.
	ACC0 113054 Terminal lama i q.		ACC0 11305 Grillo sujec. simple hoja
	ACC0 113047 Soporte lama der.		ACC0 11306 Grillo suejec. doble hoja
	ACC0 113048 Soporte lama i q.		

MECANISMO MALLORQUINA

MECANISMO
PORTA-LAMA

Referencia	Nº de lamas	Altura mín. de corte (mm)	Altura estándar (mm)	Altura ventana (mm)	
				Mínimo	Máximo
113022	6	400	460	590	650
113023	7	460	520	650	710
113024	8	520	580	710	770
113025	9	580	640	770	830
113026	10	640	700	830	890
113027	11	700	760	890	950
113028	12	760	820	950	1010
113029	13	820	880	1010	1070
113030	14	880	940	1070	1130
113031	15	940	1000	1130	1190
113032	16	1000	1060	1190	1250
113033	17	1060	1120	1250	1310
113034	18	1120	1180	1310	1370
113035	19	1180	1240	1370	1430
113036	20	1240	1300	1430	1490
113037	21	1300	1360	1490	1550
113038	22	1360	1420	1550	1610
113039	23	1420	1480	1610	1670
113040	24	1480	1540	1670	1730
-	25	1540	1600	1730	1790
-	26	1600	1660	1790	1850
-	27	1660	1720	1850	1910
-	28	1720	1780	1910	1970
-	29	1780	1840	1970	2030
-	30	1840	1900	2030	2090

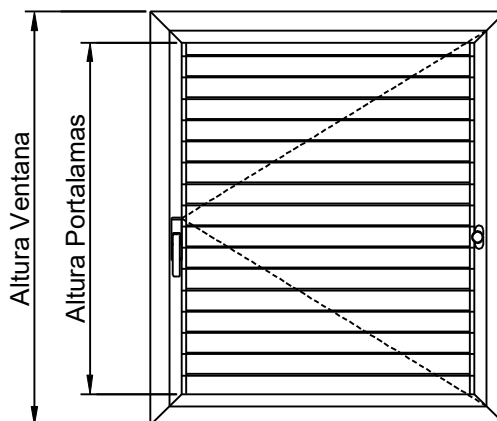
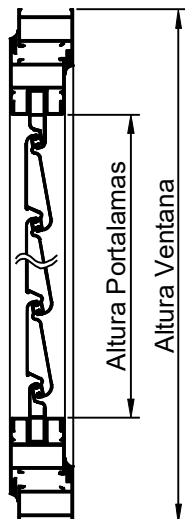
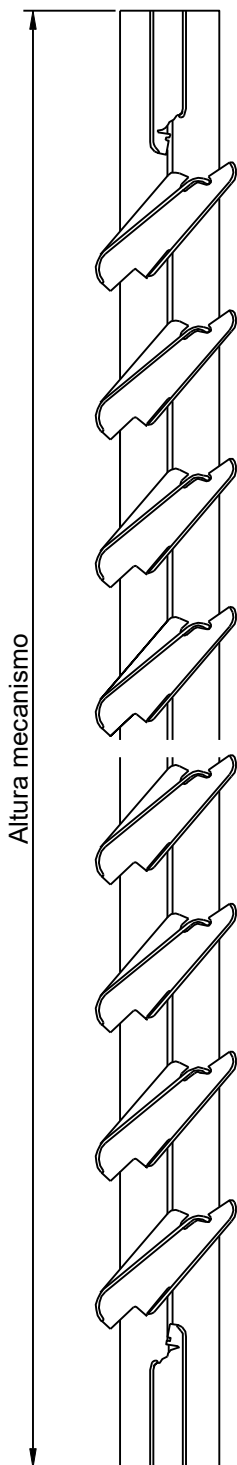



Murcia:

Dirección: Ctra. Alicante Km 1,5, Murcia

Teléfono: +34 968 27 10 50

Email: af@aluminiosfranco.es

Valencia:

Dirección: C/ Tabardo, 17, Valencia

Teléfono: +34 961 21 28 16

Email: afvalencia@aluminiosfranco.es

Tarragona:

Dirección: Pol. Ind. Constanti, Cataluña

Teléfono: +34 977 52 55 72

Email: aftarragona@aluminiosfranco.es



www.aluminiosfranco.es

